

FEATURES

- 15A switching capacity
- 1C and 2C configurations
- Transparent dust cover type, various mounting and socket available
- UL and CUL approval, File No.: E179936
- TÜV approval, File No.: R2124631

CONTACT DATA

Contact form	1C ; 2C
Contact resistance	50mΩ (measured at 1A 30VDC)
Contact rating – 1C - 2C	15A 250VAC/28VDC 10A 250VAC/28VDC
Max. switching capacity	1C: 3300VA/420W 2C: 2200VA/280W
Max. switching current	1C: 15A 2C: 10A
Max. switching voltage	250VAC / 125VDC
Contact material	Silver Alloy

CHARACTERISTICS

Insulation resistance	500MΩ at 500VDC
Dielectric strength	1500VAC, 1min. between coil to contacts 1000VAC, 1min. between open contacts
Operate time	25 ms
Release time	25 ms
Vibration resistance	10 – 55Hz, 1.5mm
Shock resistance	Malfunction:100m/s ² ;Mechanical:1000m/s ²
Humidity	40-85% RH
Ambient temperature	- 40°C to + 70°C
Life expectancy	
- Electrical	1 × 10 ⁵ operations
- Mechanical	2 × 10 ⁷ operations

COIL SPECIFICATIONS

Nominal voltage (VDC)	Pick-up voltage VDC (Max.)	Drop-out voltage VDC (Min.)	Nominal current (mA±10%)	Coil resistance (Ω±10%)	Power consumption(mW)
5	4	0.5	180	27.5	900
6	4.8	0.6	150	40	900
12	9.6	1.2	75	160	900
24	19.2	2.4	37.5	650	900
48	38.4	4.8	18.8	2600	900
110	88	11	8.2	11000	900

Nominal voltage (VAC)	Pick-up voltage VAC (Max.)	Drop-out voltage VAC (Min.)	Nominal current (mA±10%)	Coil resistance (Ω±10%)	Power consumption(VA)
6	4.8	1.8	200	11.5	1.2
12	9.6	3.6	100	46	1.2
24	19.2	7.2	50	184	1.2
48	38.4	14.4	25	735	1.2
120	96	36	10	4550	1.2
220/240	176	66	5.5	14400	1.2

ORDERING INFORMATION

ME-13F - A 012 2Z 1 D

Model No.	Coil Source	Coil Voltage	Contact Form	Mounting termination	Led
ME-13F	Nil: DC A: AC	DC: 5-110VDC AC: 6-240VAC	1Z: 1C 2Z: 2C	1 – 5 type: See the following	D: with LED

Dimensions(unit:mm)

Tolerance: ± 0.3

ME-13F-XXX-1Z1 (D)

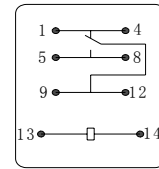
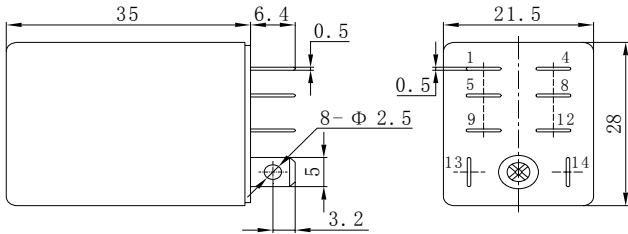

1Z1

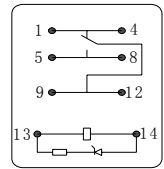

1Z1D

ME-13F-XXX-2Z1 (D)

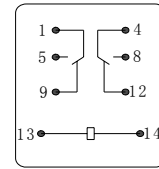
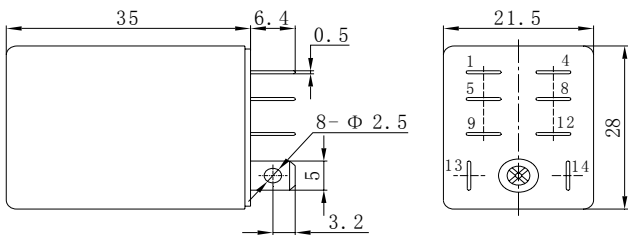

2Z1

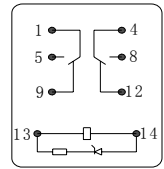

2Z1D

ME-13F-XXX-2Z2 (D)

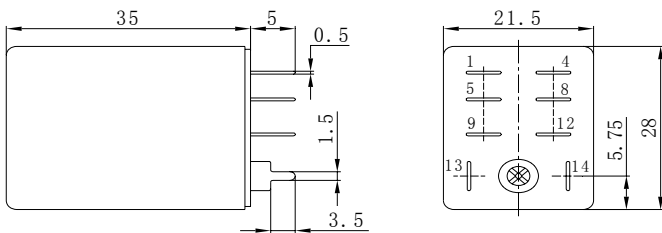

PCB LAYOUT

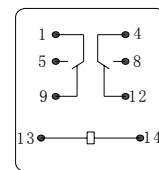
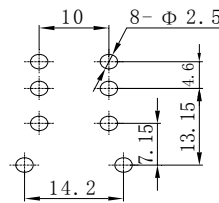

2Z2

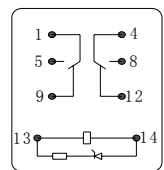

2Z2D

DIMENSIONS(UNIT:mm)

ME-13F-XXX-2Z3 (D)

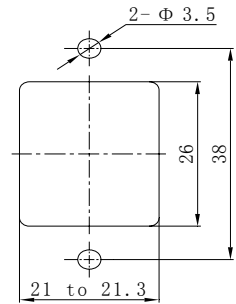
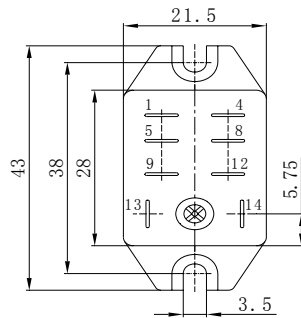
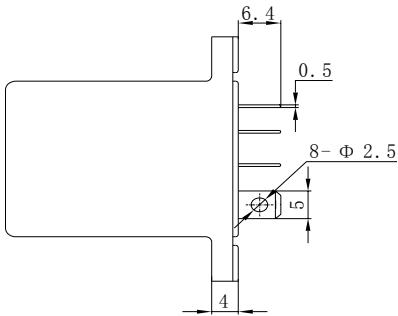

Mounting Holes

ME-13F-XXX-2Z5 (D)

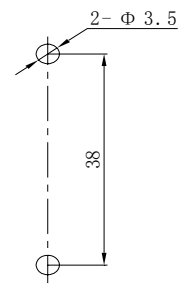
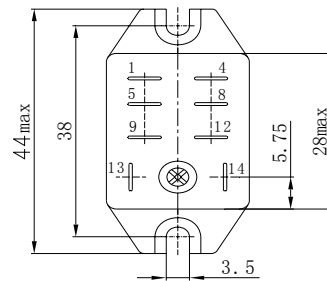
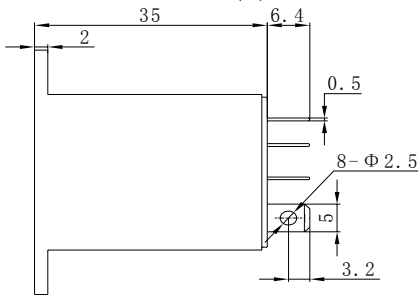

Mounting Holes

ME-13F-XXX-2Z4 (D)

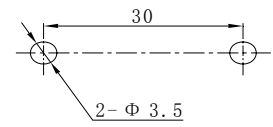
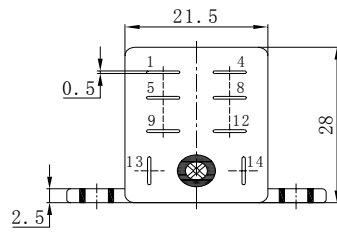
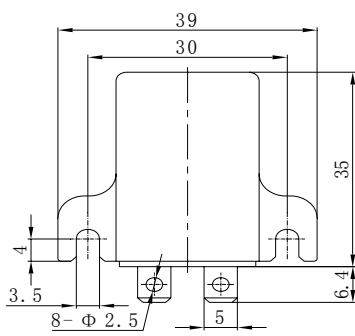

Mounting Holes