

# CHIME TONE INTERCOM

Type; 1 door — 1 room

Model; **IE-1AD(U)** (Room master station)

## INSTRUCTIONS

### 1 NAMES AND FUNCTIONS

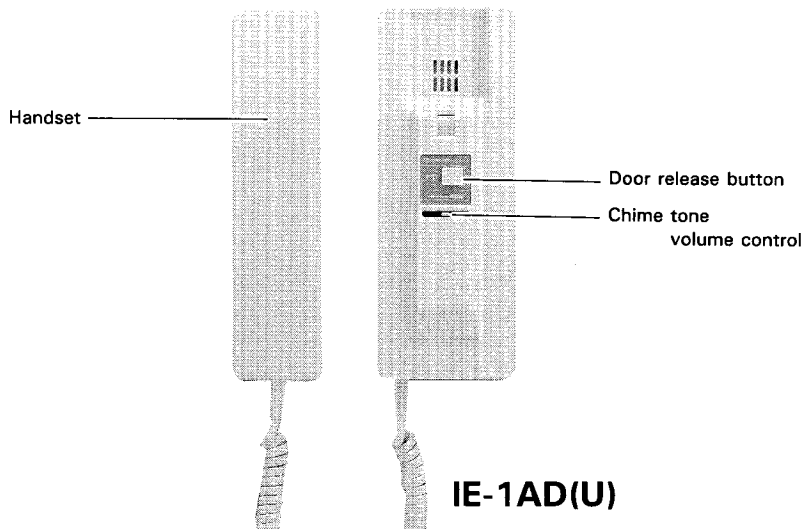

#### Mounting accessories;



Screw (× 2)  
(for mounting to  
electrical box)

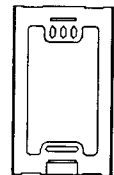

Wall-mounting  
bracket



Wood screw (× 2)  
(for mounting to  
wall surface)

### 2 FEATURES

IE-1AD(U) is a Chime Tone Intercom room master station for system with one each room station and door station (IE series).

For power supply, a bell transformer can be used for both communication and door release (Example; when EL-9S is used, select a bell transformer of AC12 ~ 16V, 450mA or more).

A power supply (DC12 ~ 24V, 160mA or more) may also be used only for communication.

- \* Thin and compact body design, matching interior decor.
- \* 4-stroke chime for doorstation call-in.
- \* Simply pick up handset to reply to the caller.
- \* Door release button on room station.
- \* Adjustable chime call volume.
- \* Optional call extension speaker.

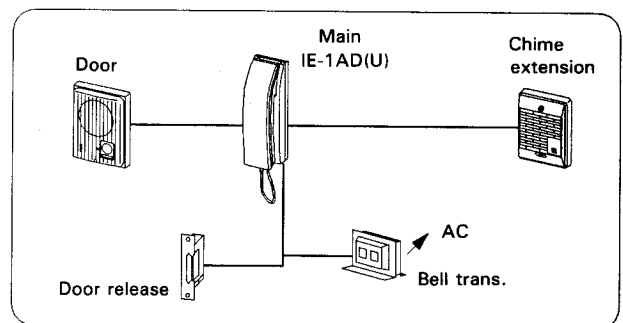

# 3

## BEFORE YOU INSTALL AND OPERATE THE EQUIPMENT — Prohibitions and precautions —

### Operation;

DO NOT HOLD HOOK SWITCH DOWN WHILE PICKING UP HANDSET. THE CHIME TONE SOUNDS THROUGH THE HANDSET RECEIVER ELEMENT AND COULD CAUSE HEARING DAMAGE.

### Installation;

- \* DO NOT CONNECT ANY TERMINAL ON ANY UNIT TO AC POWER LINES.  
When you mount IE-1AD(U) unit in place of existing bell or chime, be sure to disconnect wires from the present transformer.
- \* BE SURE TO DISCONNECT WIRES FROM BELL TRANSFORMER (or POWER SUPPLY) BEFORE YOU OPEN THE IE-1AD(U) UNIT OR MAKE WIRING CONNECTIONS.
- \* Avoid running the connecting wires through doors, windows or between furniture, which may pinch and disconnect the wires.
- \* IE-1AD(U) equipment must be installed in as dry and dust-free environment as possible.

### Maintenance;

- \* Clean your IE-1AD(U) equipment with a soft cloth dampened with neutral household cleanser. Never use thinner, lacquer or benzene, etc.
- \* Do not splash water on the door station by hose, etc.

**NEVER**



**NEVER**

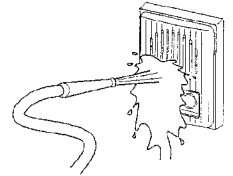

# 4

## SYSTEM COMPONENTS

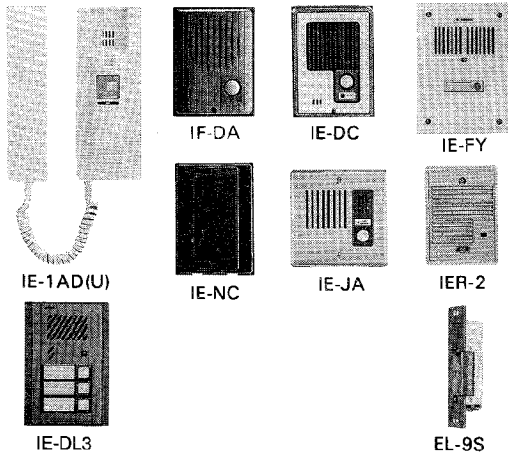

### Room station;

IE-1AD(U) : Room master station. Wall-mount.

### Door stations (one per system);

- IF-DA : with brown plastic cover (surface-mount).
- IE-DC : - do - (surface-mount).
- IE-NC : - do - (semi-flush mount).
- IE-JA : with stainless steel cover (flush-mount).
- IE-FY : with aluminum cover (flush-mount).
- IE-DL1 : 1-call, with brown anodized aluminum cover (surface-mount).
- IE-DL2 : - do -, 2-call.
- IE-DL3 : - do -, 3-call (each with illumination lamp).

### Options;

- IER-2 : Call extension speaker, with volume control.
- EL-9S : Door release. AC 12V, 0.35A. Requires a separate bell transformer.

Notes; Your IE-1AD(U) can not work with IB/IC/ID series door stations. As to call extension, ICR-1 can be included in IE-1AD(U) system.

# 5

## INSTALLATION

### (1) Actual terminal location;

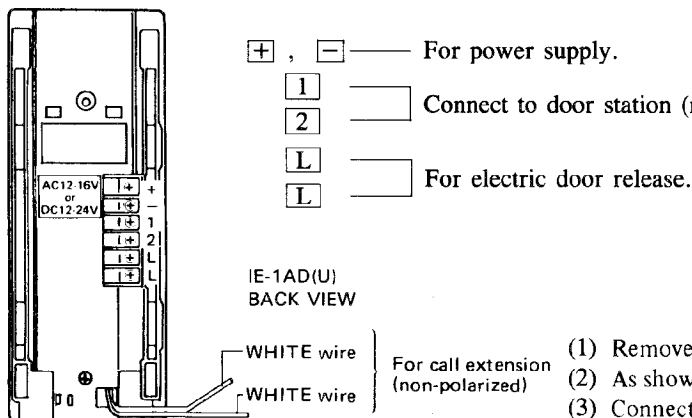

### CASE & CHASSIS INSIDE VIEW

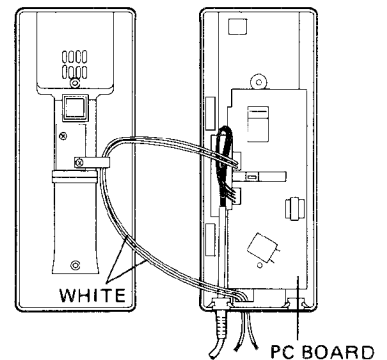

- (1) Remove 2 screws on back of the chassis and separate front case and chassis.
- (2) As shown, take out two WHITE wires thru a hole on the chassis.
- (3) Connect 2 wires to the wires from the IER-2 (non-polarized).

## (2) Wall-mounting installation;

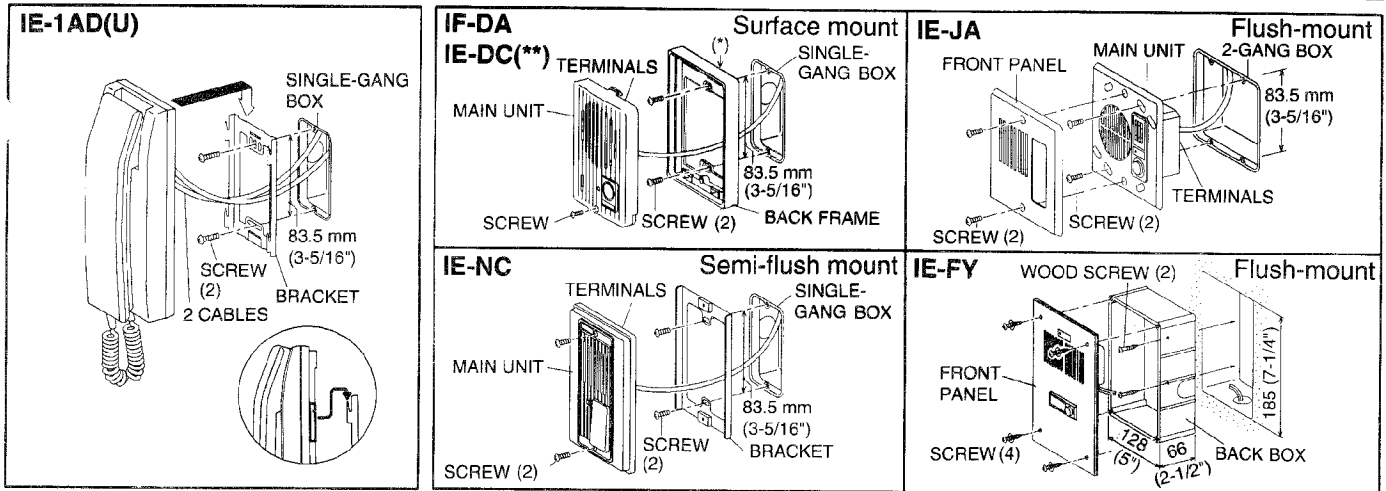

\***Master stations;** Attach the mounting bracket to wall or single-gang box with the supplied wood screws or screws. Insert the prongs of the bracket into the holes of the body and pull the body downward. Be careful not to attach the bracket upside down.

\* **Door station;** (\*) When mounting to wall directly, remove the outlet part (\*) on top or bottom of back frame to pass cable.

(\*\*) Illustrates IF-DA's, and IE-DC mounts in the same manner.

# 6

## WIRING DIAGRAM

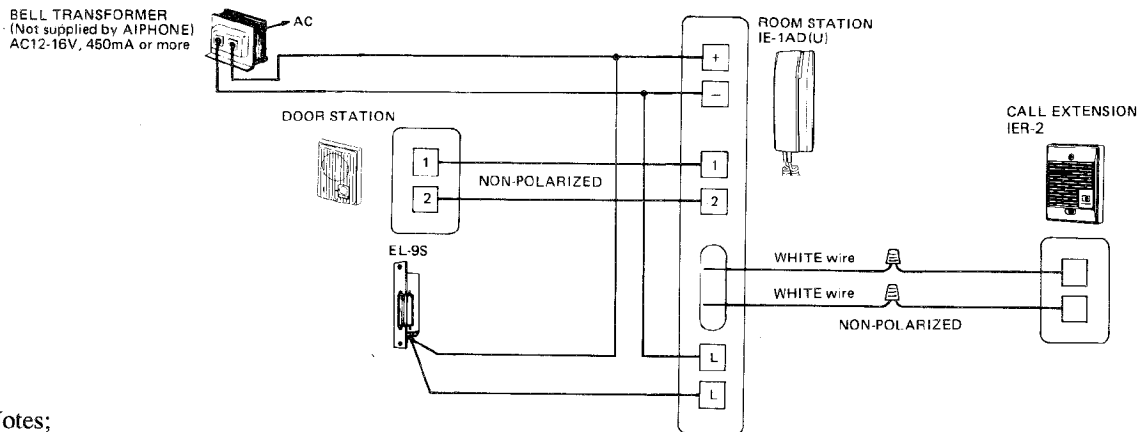

Notes;

- (1) Bell transformer for both communication and door release; AC 12-16V, 450mA or more (when EL-9S is used). AC 12-16V, 700mA or more (when door release of other manufacture is used).
- (2) Door release; Use a door release EL-9S (AC 12V, 350mA) or other manufacture's which does not exceed AC 12-16V 500mA, when powered by a system's bell transformer.
- (3) Locate a system's power supply within a 10m/33' distance from main room station, using 0.65 mm dia./22AWG wires.

# 7

## SPECIFICATIONS

Power source: IE-1AD(U); Powered by a bell transformer AC 12-16V, 180mA OR a power supply DC 12-24V, 160mA.

Current consumption: Max. 180mA (AC 12-16V). Max. 160mA (DC 12-24V).

Calling: 4-stroke electronic chime (w/slide volume switch).

Wiring: 2 wires (to door station) (non-polarized)

2 wires (to door release) (must be separated from communication's cable).

Door release button contact capacity: DC/AC 24V, 0.5A.

Wiring distance: \*Between IE-1AD(U) & door station;

AWG	24AWG	22AWG	20AWG	18AWG
Distance	300'	500'	750'	1,180'
Diameter	0.5 mm	0.65 mm	0.8 mm	1.0 mm
Distance	90 m	150 m	230 m	360 m

Dimensions: (H x W x D) 210 x 80 x 58 (mm); 8-1/4" x 3-1/8" x 2-5/16"

Weight: Approx. 450 g (1 lb.).

# 8

## OPERATIONS

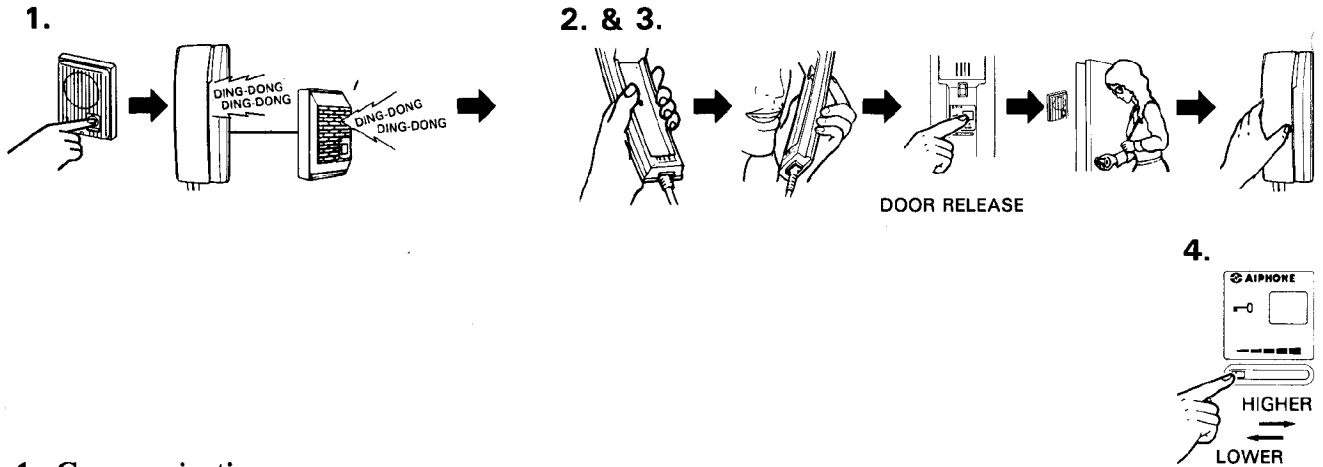

### 1. Communication;

At door station;

Momentarily depress CALL button. After room station replies, talk handsfree.

At room station;

Incoming call is announced by 4-stroke chime at IE-1AD(U) and IER-2, if installed. To reply, simply pick up handset at IE-1AD(U). After communication, hang up handset onto its cradle properly.

### 2. To operate door release;

While holding handset, depress and hold DOOR RELEASE button on IE-1AD(U). The visitor may open the door while buzzing sound is heard.

### 3. Monitoring door station;

Pick up handset and you can monitor the door station.

### 4. To adjust chime volume;

Adjust chime volume as desired by the slide switch on IE-1AD(U), according to the room conditions.

The chime volume at IER-2 can be changed separately by the switch provided.

### WARRANTY

Aiphone warrants its products to be free from defects of material and workmanship under normal use and service for a period of one year after delivery to the ultimate user and will repair free of charge or replace at no charge, should it become defective upon which examination shall disclose to be defective and under warranty. Aiphone reserves unto itself the sole right to make the final decision whether there is a defect in materials and/or workmanship; and whether or not the product is within the warranty.

This warranty shall not apply to any Aiphone product which has been subject to misuse, neglect, accident, or to use in violation of instructions furnished, nor extended to units which have been repaired or altered outside of the factory.

This warranty does not cover batteries or damage caused by batteries used in connection with the product.

This warranty covers bench repairs only, and any repairs must be made at the shop or place designated in writing by Aiphone.

Aiphone will not be responsible for any costs incurred involving on site service calls.

Aiphone Co., Ltd., Nagoya, Japan  
Aiphone Corporation, Bellevue, WA, USA

IE-1AD(U)-(E) 1192D