

CD40147B Types

10-Line to 4-Line BCD Priority Encoder

High-Voltage Types (20-Volt Rating)

The CD40147B CMOS encoder features priority encoding of the inputs to ensure that only the highest-order data line is encoded. Ten data input lines (0-9) are encoded to four-line (8, 4, 2, 1) BCD. The highest priority line is line 9. All four output lines are logic 1 (V_{SS}) when all input lines are logic 0. All inputs and outputs are buffered, and each output can drive one TTL low-power Schottky load. The CD40147B is functionally similar to the TTL5474/147 if pin 15 is tied low.

The CD40147B types are supplied in 16-lead dual-in-line plastic packages (E suffix), 16-lead small-outline packages (M, M96, MT, and NSR suffixes), and 16-lead thin shrink small-outline packages (PW and PWR suffixes).

Features:

- Encodes 10-line to 4-line BCD
- Active low inputs and outputs
- Standardized, symmetrical output characteristics
- 100% tested for quiescent current at 20 V
- 5-V, 10-V, and 15-V parametric ratings
- Meets all requirements of JEDEC Tentative Standard No. 13A, "Standard Specifications for Description of 'B' Series CMOS Devices"
- Maximum input current of 1 μ A at 18 V over full package-temperature range; 100 nA at 18 V and 25°C
- Noise margin (full package-temperature range) =
 - 1 V at $V_{DD} = 5$ V
 - 2 V at $V_{DD} = 10$ V
 - 2.5 V at $V_{DD} = 15$ V

Applications:

- Keyboard encoding
- 10-line to BCD encoding
- Range selection

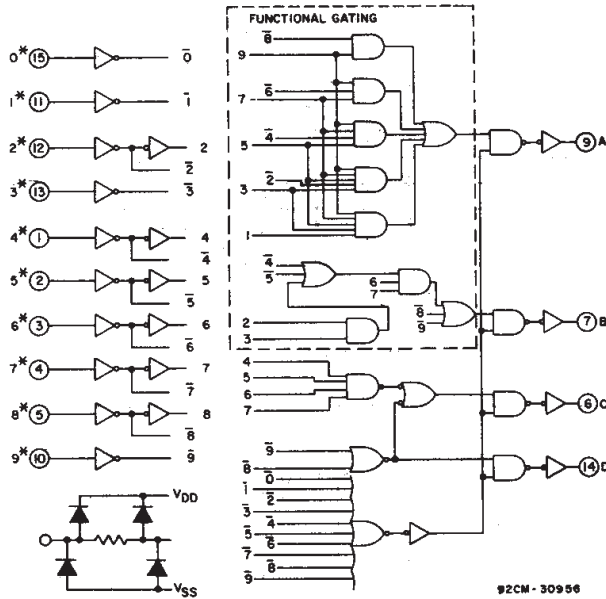
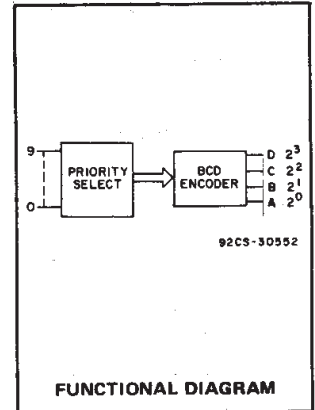

* INPUTS PROTECTED BY COS/MOS PROTECTION NETWORK

Fig. 1 - CD40147B logic diagram.

RECOMMENDED OPERATING CONDITIONS

For maximum reliability, nominal operating conditions should be selected so that operation is always within the following range:

CHARACTERISTIC	LIMITS		UNITS
	Min.	Max.	
Supply Voltage Range (For T_A = Full Package Temperature Range)	3	18	V

TRUTH TABLE (Negative Logic)

INPUTS										OUTPUTS			
0	1	2	3	4	5	6	7	8	9	D	C	B	A
0	0	0	0	0	0	0	0	0	0	1	1	1	1
1	0	0	0	0	0	0	0	0	0	0	0	0	0
X	1	0	0	0	0	0	0	0	0	0	0	0	1
X	X	1	0	0	0	0	0	0	0	0	0	1	0
X	X	X	1	0	0	0	0	0	0	0	0	1	1
X	X	X	X	1	0	0	0	0	0	0	1	0	0
X	X	X	X	X	1	0	0	0	0	0	1	0	1
X	X	X	X	X	X	1	0	0	0	0	1	1	0
X	X	X	X	X	X	X	1	0	0	0	1	1	1
X	X	X	X	X	X	X	X	1	0	1	0	0	0
X	X	X	X	X	X	X	X	X	1	1	0	0	1

0 = High Level 1 = Low Level X = Don't Care

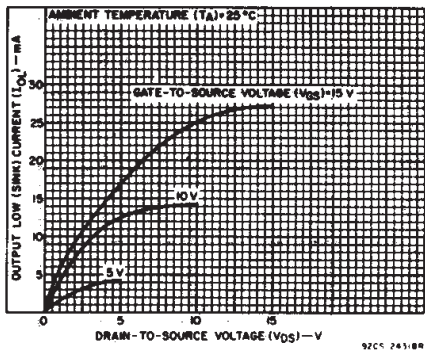

Fig. 2 - Typical output low (sink) current characteristics.

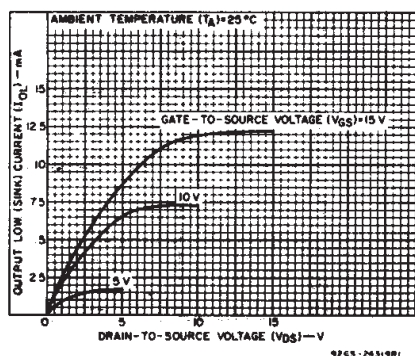

Fig. 3 - Minimum output low (sink) current characteristics.

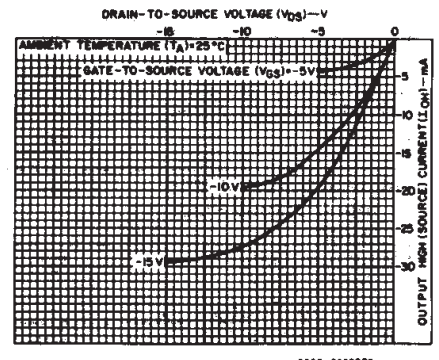

Fig. 4 - Typical output high (source) current characteristics.

CD40147B Types

MAXIMUM RATINGS, Absolute-Maximum Values:

DC SUPPLY-VOLTAGE RANGE, (V _{DD})	-0.5V to +20V
Voltages referenced to V _{SS} Terminal	
INPUT VOLTAGE RANGE, ALL INPUTS	-0.5V to V _{DD} +0.5V
DC INPUT CURRENT, ANY ONE INPUT	±10mA
POWER DISSIPATION PER PACKAGE (P _D):	
For T _A = -55°C to +100°C	500mW
For T _A = +100°C to +125°C	Derate Linearly at 12mW/°C to 200mW
DEVICE DISSIPATION PER OUTPUT TRANSISTOR	
FOR T _A = FULL PACKAGE-TEMPERATURE RANGE (All Package Types)	100mW
OPERATING-TEMPERATURE RANGE (T _A)	-55°C to +125°C
STORAGE TEMPERATURE RANGE (T _{stg})	-65°C to +150°C
LEAD TEMPERATURE (DURING SOLDERING):	
At distance 1/16 ± 1/32 inch (1.59 ± 0.79mm) from case for 10s max	+265°C

STATIC ELECTRICAL CHARACTERISTICS

CHARACTERISTIC	CONDITIONS			LIMITS AT INDICATED TEMPERATURES (°C)							UNITS
	V _O (V)	V _{IN} (V)	V _{DD} (V)	-55	-40	+85	+125	+25			
								Min.	Typ.	Max.	
Quiescent Device Current, I _{DD} Max.	—	0.5	5	5	5	150	150	—	0.04	5	μA
Output Low (Sink) Current I _{OL} Min.	0.4	0.5	5	0.64	0.61	0.42	0.36	0.51	1	—	
Output (Source) Current, I _{OH} Min.	4.6	0.5	5	-0.64	-0.61	-0.42	-0.36	-0.51	-1	—	
Output Voltage: Low-Level, V _{OL} Max.	—	0.5	5	0.05			—	0	0.05	—	V
Output Voltage: High-Level, V _{OH} Min.	—	0.5	5	4.95			4.95	5	—		
Input Low Voltage, V _{IL} Max.	0.5, 4.5	—	5	1.5			—	—	1.5		
Input High Voltage, V _{IH} Min.	0.5, 4.5	—	5	3.5			3.5	—	—	V	
Input Current I _{IN} Max.	—	0.18	18	±0.1	±0.1	±1	±1	—	±10 ⁻⁵		±0.1

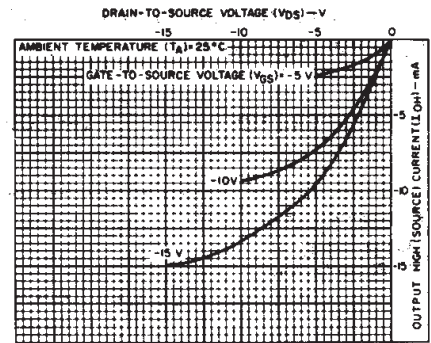

Fig. 5 — Minimum output high (source) current characteristics.

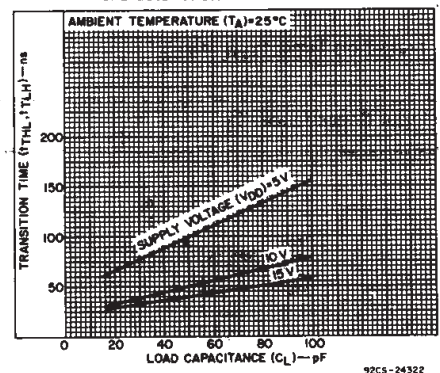

Fig. 6 — Typical transition time as a function of load capacitance.

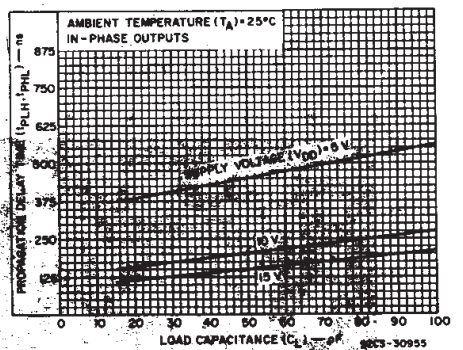

Fig. 7 — Propagation delay time as a function of load capacitance.

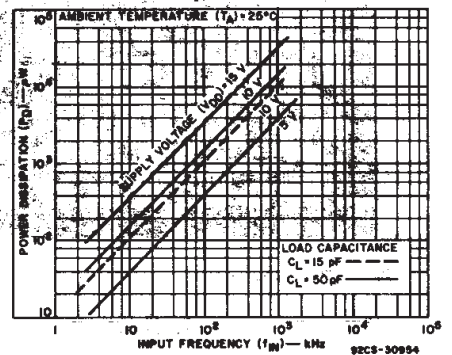

Fig. 8 — Typical dynamic power dissipation as a function of input frequency.

3
COMMERCIAL CMOS
HIGH VOLTAGE ICs

CD40147B Types

DYNAMIC ELECTRICAL CHARACTERISTICS at $T_A = 25^\circ\text{C}$, Input $t_r, t_f = 20 \text{ ns}$,
 $C_L = 50 \text{ pF}$, $R_L = 200 \text{ k}\Omega$

CHARACTERISTIC	TEST CONDITIONS	LIMITS ALL TYPES		UNITS	
		V_{DD} (V)	Typ.		Max.
Propagation Delay Time, t_{PLH}, t_{PHL} In-Phase Output	Any input to any output	5	450	900	ns
		10	200	400	
		15	150	300	
Out-of-Phase Output		5	425	850	ns
		10	175	350	
		15	125	250	
Transition Time, t_{THL}, t_{TLH}	5	100	200	ns	
	10	50	100		
	15	40	80		
Input Capacitance, C_1	Any Input	5	7.5	pF	

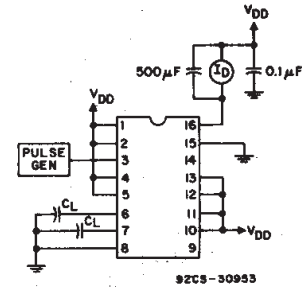

Fig. 9 – Dynamic power dissipation test circuit.

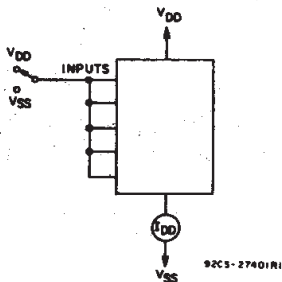

Fig. 10 – Quiescent device current test circuit.

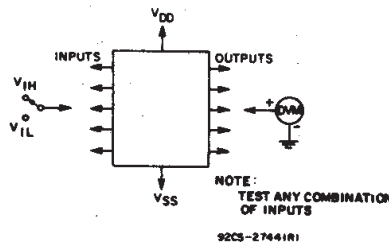

Fig. 11 – Input voltage test circuit.

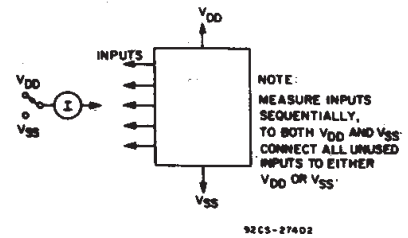
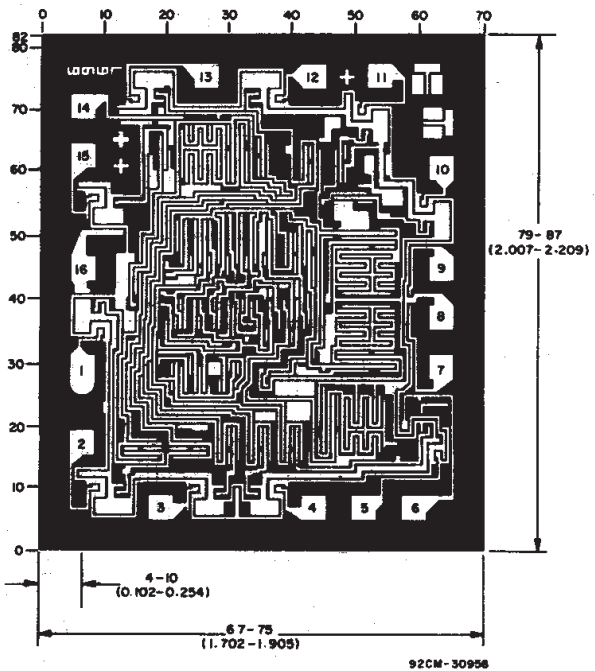
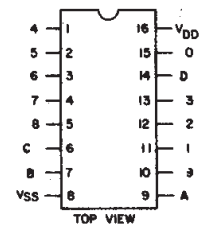

Fig. 12 – Input current test circuit.



Dimensions and pad layout for CD40147BH



CD40147B
 TERMINAL
 ASSIGNMENT

Dimensions in parentheses are in millimeters and are derived from the basic inch dimensions as indicated. Grid graduations are in mils (10^{-3} inch).

PACKAGING INFORMATION

Orderable Device	Status ⁽¹⁾	Package Type	Package Drawing	Pins	Package Qty	Eco Plan ⁽²⁾	Lead/Ball Finish	MSL Peak Temp ⁽³⁾
CD40147BE	ACTIVE	PDIP	N	16	25	Pb-Free (RoHS)	CU NIPDAU	N / A for Pkg Type
CD40147BEE4	ACTIVE	PDIP	N	16	25	Pb-Free (RoHS)	CU NIPDAU	N / A for Pkg Type
CD40147BM	ACTIVE	SOIC	D	16	40	Green (RoHS & no Sb/Br)	CU NIPDAU	Level-1-260C-UNLIM
CD40147BM96	ACTIVE	SOIC	D	16	2500	Green (RoHS & no Sb/Br)	CU NIPDAU	Level-1-260C-UNLIM
CD40147BM96E4	ACTIVE	SOIC	D	16	2500	Green (RoHS & no Sb/Br)	CU NIPDAU	Level-1-260C-UNLIM
CD40147BME4	ACTIVE	SOIC	D	16	40	Green (RoHS & no Sb/Br)	CU NIPDAU	Level-1-260C-UNLIM
CD40147BMT	ACTIVE	SOIC	D	16	250	Green (RoHS & no Sb/Br)	CU NIPDAU	Level-1-260C-UNLIM
CD40147BMTE4	ACTIVE	SOIC	D	16	250	Green (RoHS & no Sb/Br)	CU NIPDAU	Level-1-260C-UNLIM
CD40147BNSR	ACTIVE	SO	NS	16	2000	Green (RoHS & no Sb/Br)	CU NIPDAU	Level-1-260C-UNLIM
CD40147BNSRE4	ACTIVE	SO	NS	16	2000	Green (RoHS & no Sb/Br)	CU NIPDAU	Level-1-260C-UNLIM
CD40147BPW	ACTIVE	TSSOP	PW	16	90	Green (RoHS & no Sb/Br)	CU NIPDAU	Level-1-260C-UNLIM
CD40147BPWE4	ACTIVE	TSSOP	PW	16	90	Green (RoHS & no Sb/Br)	CU NIPDAU	Level-1-260C-UNLIM
CD40147BPWR	ACTIVE	TSSOP	PW	16	2000	Green (RoHS & no Sb/Br)	CU NIPDAU	Level-1-260C-UNLIM
CD40147BPWRE4	ACTIVE	TSSOP	PW	16	2000	Green (RoHS & no Sb/Br)	CU NIPDAU	Level-1-260C-UNLIM

⁽¹⁾ The marketing status values are defined as follows:

ACTIVE: Product device recommended for new designs.

LIFEBUY: TI has announced that the device will be discontinued, and a lifetime-buy period is in effect.

NRND: Not recommended for new designs. Device is in production to support existing customers, but TI does not recommend using this part in a new design.

PREVIEW: Device has been announced but is not in production. Samples may or may not be available.

OBSELETE: TI has discontinued the production of the device.

⁽²⁾ Eco Plan - The planned eco-friendly classification: Pb-Free (RoHS), Pb-Free (RoHS Exempt), or Green (RoHS & no Sb/Br) - please check <http://www.ti.com/productcontent> for the latest availability information and additional product content details.

TBD: The Pb-Free/Green conversion plan has not been defined.

Pb-Free (RoHS): TI's terms "Lead-Free" or "Pb-Free" mean semiconductor products that are compatible with the current RoHS requirements for all 6 substances, including the requirement that lead not exceed 0.1% by weight in homogeneous materials. Where designed to be soldered at high temperatures, TI Pb-Free products are suitable for use in specified lead-free processes.

Pb-Free (RoHS Exempt): This component has a RoHS exemption for either 1) lead-based flip-chip solder bumps used between the die and package, or 2) lead-based die adhesive used between the die and leadframe. The component is otherwise considered Pb-Free (RoHS compatible) as defined above.

Green (RoHS & no Sb/Br): TI defines "Green" to mean Pb-Free (RoHS compatible), and free of Bromine (Br) and Antimony (Sb) based flame retardants (Br or Sb do not exceed 0.1% by weight in homogeneous material)

⁽³⁾ MSL, Peak Temp. -- The Moisture Sensitivity Level rating according to the JEDEC industry standard classifications, and peak solder temperature.

Important Information and Disclaimer:The information provided on this page represents TI's knowledge and belief as of the date that it is

provided. TI bases its knowledge and belief on information provided by third parties, and makes no representation or warranty as to the accuracy of such information. Efforts are underway to better integrate information from third parties. TI has taken and continues to take reasonable steps to provide representative and accurate information but may not have conducted destructive testing or chemical analysis on incoming materials and chemicals. TI and TI suppliers consider certain information to be proprietary, and thus CAS numbers and other limited information may not be available for release.

In no event shall TI's liability arising out of such information exceed the total purchase price of the TI part(s) at issue in this document sold by TI to Customer on an annual basis.

N (R-PDIP-T**)

PLASTIC DUAL-IN-LINE PACKAGE

16 PINS SHOWN



- NOTES:
- A. All linear dimensions are in inches (millimeters).
 - B. This drawing is subject to change without notice.
 - C Falls within JEDEC MS-001, except 18 and 20 pin minimum body length (Dim A).
 - D The 20 pin end lead shoulder width is a vendor option, either half or full width.

4040049/E 12/2002

MECHANICAL DATA

NS (R-PDSO-G**)

PLASTIC SMALL-OUTLINE PACKAGE

14-PINS SHOWN



- NOTES:
- A. All linear dimensions are in millimeters.
 - B. This drawing is subject to change without notice.
 - C. Body dimensions do not include mold flash or protrusion, not to exceed 0,15.

PW (R-PDSO-G**)

PLASTIC SMALL-OUTLINE PACKAGE

14 PINS SHOWN



4040064/F 01/97

- NOTES: A. All linear dimensions are in millimeters.
 B. This drawing is subject to change without notice.
 C. Body dimensions do not include mold flash or protrusion not to exceed 0,15.
 D. Falls within JEDEC MO-153

IMPORTANT NOTICE

Texas Instruments Incorporated and its subsidiaries (TI) reserve the right to make corrections, modifications, enhancements, improvements, and other changes to its products and services at any time and to discontinue any product or service without notice. Customers should obtain the latest relevant information before placing orders and should verify that such information is current and complete. All products are sold subject to TI's terms and conditions of sale supplied at the time of order acknowledgment.

TI warrants performance of its hardware products to the specifications applicable at the time of sale in accordance with TI's standard warranty. Testing and other quality control techniques are used to the extent TI deems necessary to support this warranty. Except where mandated by government requirements, testing of all parameters of each product is not necessarily performed.

TI assumes no liability for applications assistance or customer product design. Customers are responsible for their products and applications using TI components. To minimize the risks associated with customer products and applications, customers should provide adequate design and operating safeguards.

TI does not warrant or represent that any license, either express or implied, is granted under any TI patent right, copyright, mask work right, or other TI intellectual property right relating to any combination, machine, or process in which TI products or services are used. Information published by TI regarding third-party products or services does not constitute a license from TI to use such products or services or a warranty or endorsement thereof. Use of such information may require a license from a third party under the patents or other intellectual property of the third party, or a license from TI under the patents or other intellectual property of TI.

Reproduction of information in TI data books or data sheets is permissible only if reproduction is without alteration and is accompanied by all associated warranties, conditions, limitations, and notices. Reproduction of this information with alteration is an unfair and deceptive business practice. TI is not responsible or liable for such altered documentation.

Resale of TI products or services with statements different from or beyond the parameters stated by TI for that product or service voids all express and any implied warranties for the associated TI product or service and is an unfair and deceptive business practice. TI is not responsible or liable for any such statements.

Following are URLs where you can obtain information on other Texas Instruments products and application solutions:

Products		Applications	
Amplifiers	amplifier.ti.com	Audio	www.ti.com/audio
Data Converters	dataconverter.ti.com	Automotive	www.ti.com/automotive
DSP	dsp.ti.com	Broadband	www.ti.com/broadband
Interface	interface.ti.com	Digital Control	www.ti.com/digitalcontrol
Logic	logic.ti.com	Military	www.ti.com/military
Power Mgmt	power.ti.com	Optical Networking	www.ti.com/opticalnetwork
Microcontrollers	microcontroller.ti.com	Security	www.ti.com/security
Low Power Wireless	www.ti.com/lpw	Telephony	www.ti.com/telephony
		Video & Imaging	www.ti.com/video
		Wireless	www.ti.com/wireless

Mailing Address: Texas Instruments
Post Office Box 655303 Dallas, Texas 75265