HA17558 Serise

Dual Operational Amplifier

HITACHI

Description

HA17558 is dual operational amplifiers which provides internal frequency compensation and high performance. It can be applied widely to measuring control equipment and to general Use. The two amplifiers share a common bias network and power supply leads.

Features

- High voltage Gain: 104dB (Typ)
- High speed: 1V/ μ s
- Continuous short-circuit protection
- Low-noise operational amplifiers
- Internal frequency compensation

Ordering Information

Type No.	Application	Package
HA17558FP	Industrial use	FP-8D
HA17558F	Commercial use	FP-8D
HA17558	Commercial use	DP-8
HA17558PS	Industrial use	DP-8

Pin Arrangement

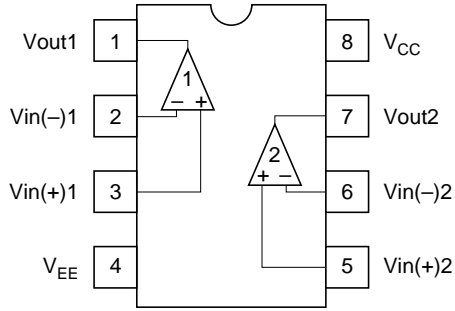

(Top View)

Circuit Schematic (1/2)

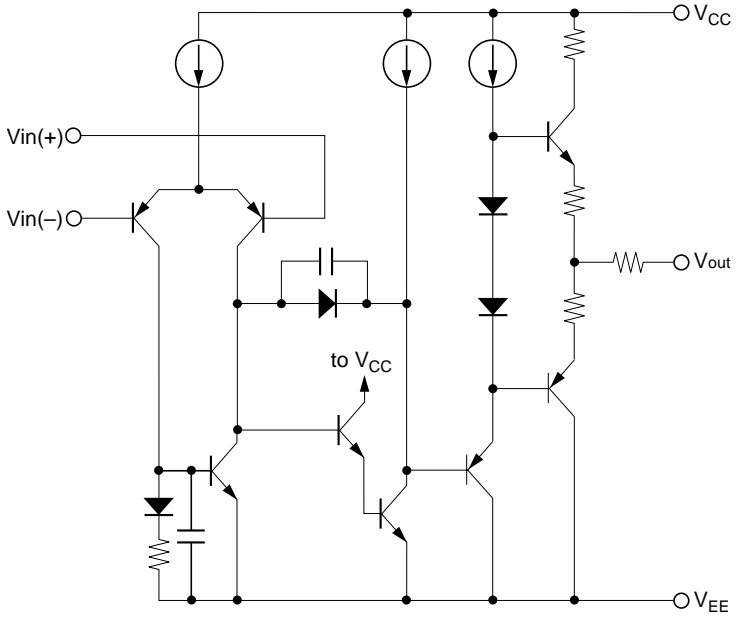

Absolute Maximum Ratings (Ta = 25°C)

Item	Symbol	Ratings				Unit
		HA17558	HA17558 PS	HA17558 F	HA17558 FP	
Supply voltage	V _{CC}	+18	+18	+18	+18	V
	V _{EE}	-18	-18	-18	-18	V
Differential input voltage	V _{IN (diff)}	±30	±30	±30	±30	V
Common-mode input voltage	V _{CM} *3	±15	±15	±15	±15	V
Power dissipation	P _T	670*1	670*1	385*2	385*2	mW
Operating temperature	Topr	-20 to +75	-20 to +75	-20 to +75	-20 to +75	-20 to +75
Storage temperature	Tstg	-55 to +125	-55 to +125	-55 to +125	-55 to +125	°C

- Notes: 1. These are the allowable values up to Ta = 45 °C. Derate by 8.3mW/°C above that temperature.
 2. These are the allowable values up to Ta = 31 °C mounting on 30% wiring density glass epoxy board. Derate by 7.14mW/°C above that temperature.
 3. If the supply voltage is less than ±15V, input voltage should be less than supply voltage.

Electrical Characteristics (Ta = 25°C, V_{CC} = +15V, V_{EE} = -15V)

Item	Symbol	Min	Typ	Max	Unit	Test conditions
Input offset voltage	V _{IO}	—	0.5	6	mV	R _s ≤ 10kΩ
Input offset current	I _{IO}	—	5	200	nA	
Input bias current	I _{IB}	—	50	500	nA	
Voltage gain	A _{VD}	86	104	—	dB	R _L ≥ 2kΩ, V _O = ±10V
Maximum output voltage	V _{op-p}	±12	±14	—	V	R _L ≥ 10kΩ
Maximum output voltage	V _{op-p}	±10	±12.4	—	V	R _L ≥ 2kΩ
Common mode input voltage range	V _{CM}	±12	±14	—	V	
Common mode rejection ratio	CMR	70	100	—	dB	R _s ≤ 10kΩ
Supply voltage rejection ratio	PSRR	—	10	150	μV/V	R _s ≤ 10kΩ
Power dissipation	Pd	—	90	170	mW	2-channel, No load
Slew rate	SR	—	1.0	—	V/μs	A _{VD} = 1
Equivalent input noise voltage	V _{NI}	—	6	—	μVp-p	R _s = 1kΩ, f = 1Hz to 1kHz
Channel separation	CS	—	105	—	dB	f = 1kHz

Characteristic Curves

Open Loop Voltage Gain vs. Frequency

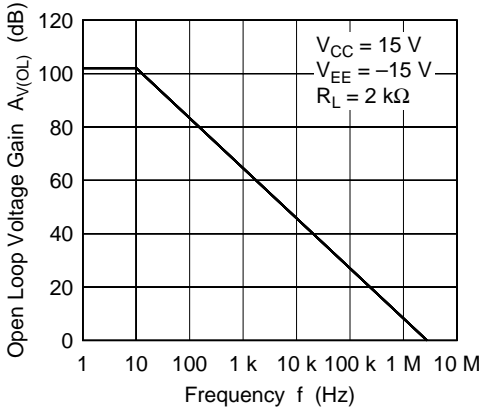

Maximum Output Voltage vs. Frequency

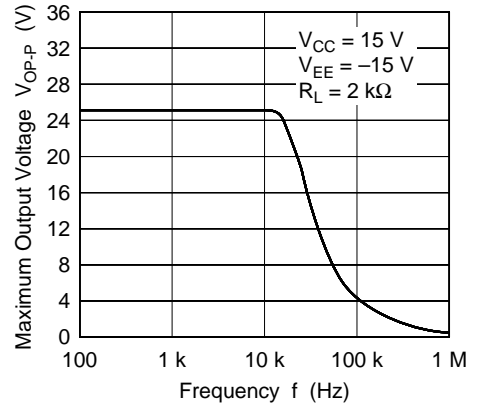

Power Supply Rejection Ratio vs. Ambient Temperature

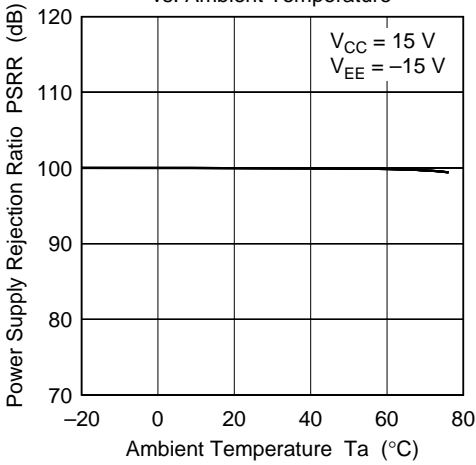

Voltage Gain vs. Ambient Temperature

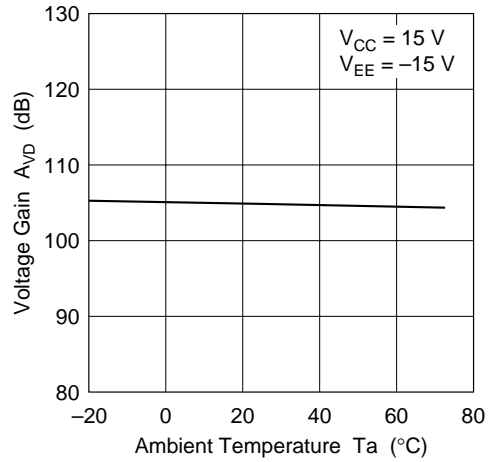

Power Supply Rejection Ratio vs. Frequency

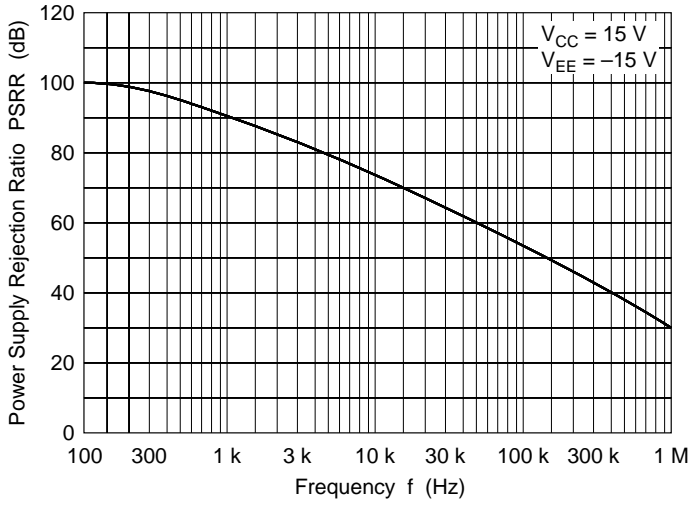

Common-mode Rejection Ratio vs. Frequency

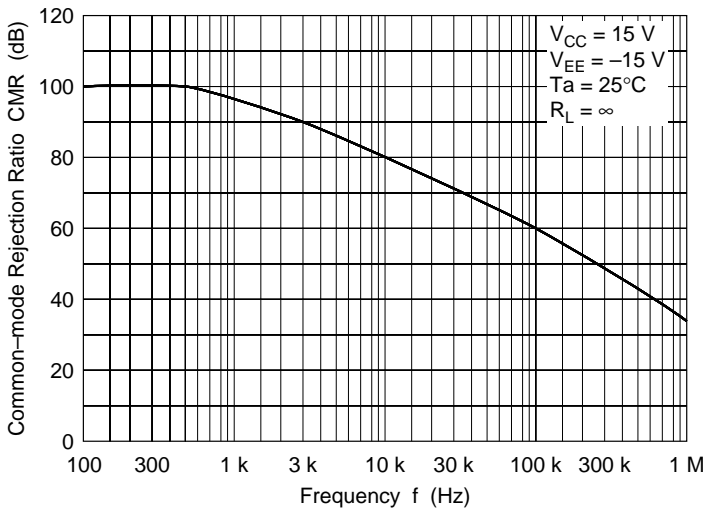

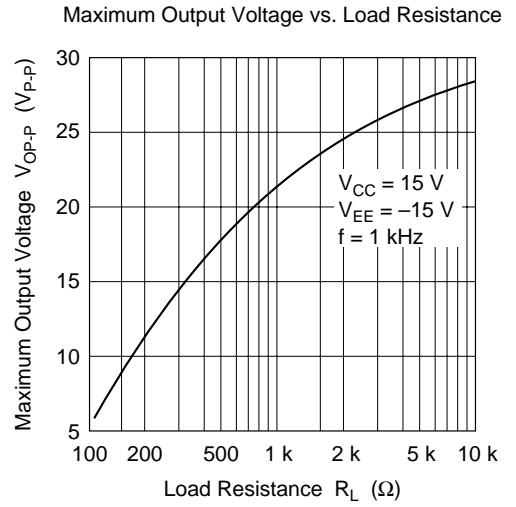
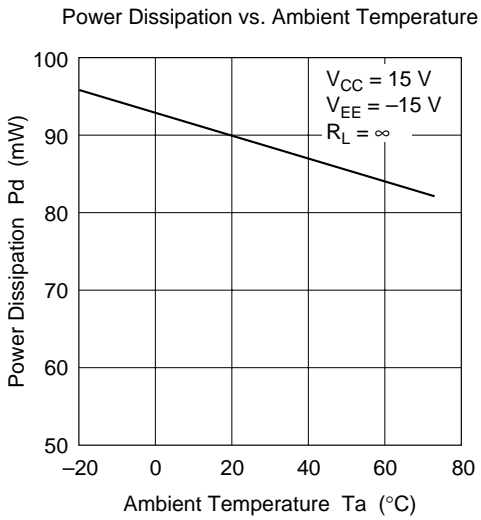
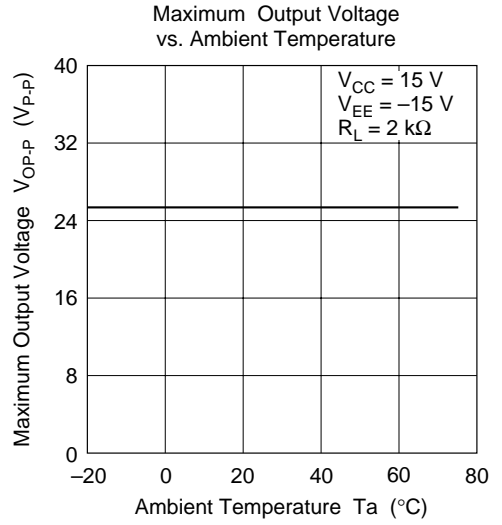
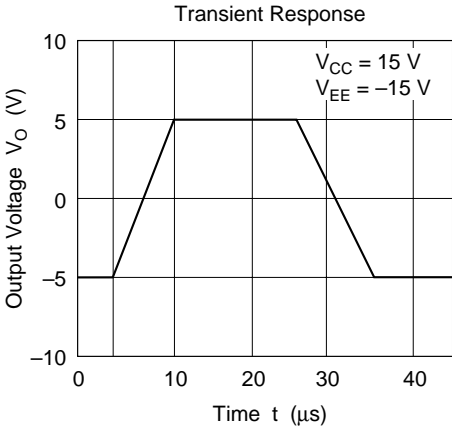

Supply Current vs. Supply Voltage

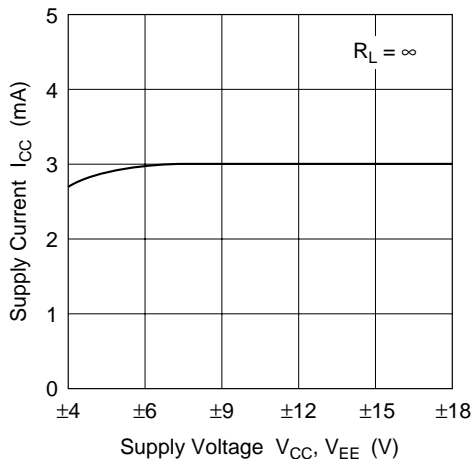

Common-mode Input Voltage vs. Supply Voltage

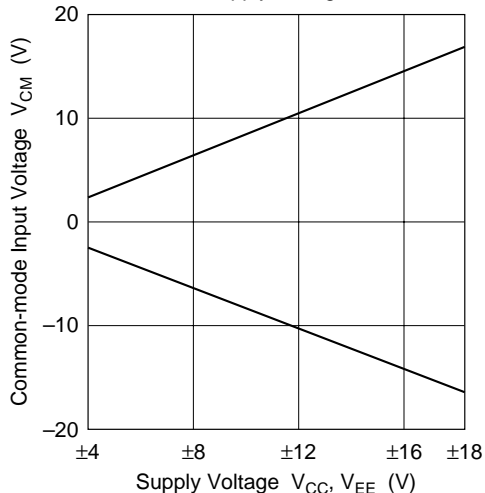

Input Bias Current vs. Ambient Temperature

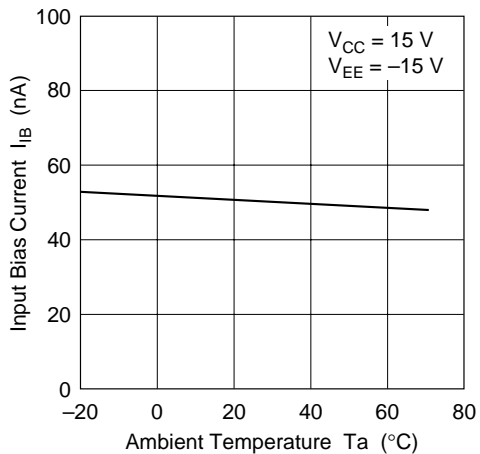

Slew Rate vs. Supply Voltage

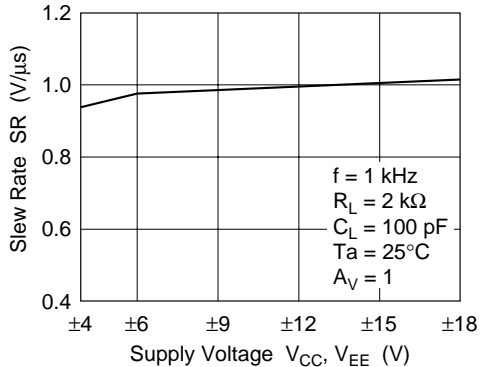

Input Offset Current vs. Ambient Temperature

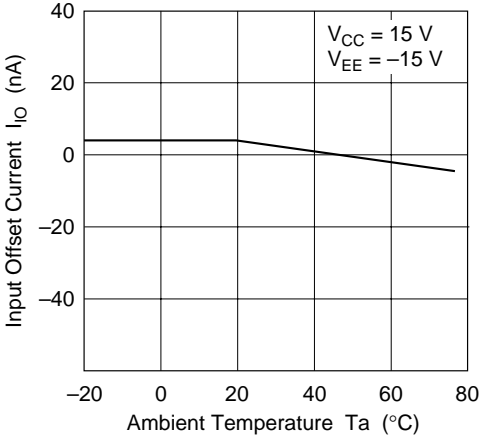

Input Offset Voltage vs. Supply Voltage

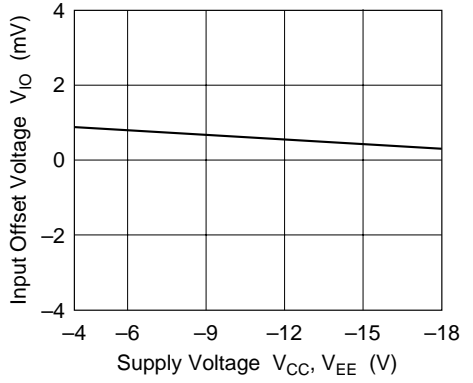

Voltage Gain vs. Supply Voltage

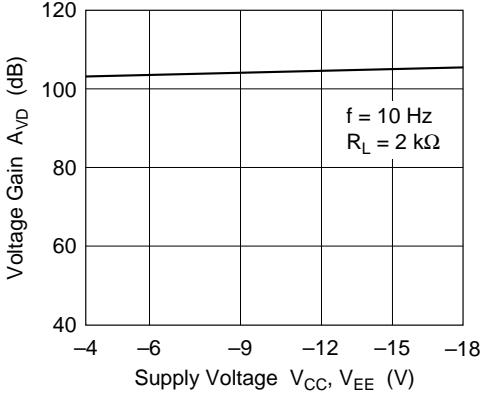

Slew Rate vs. Ambient Temperature

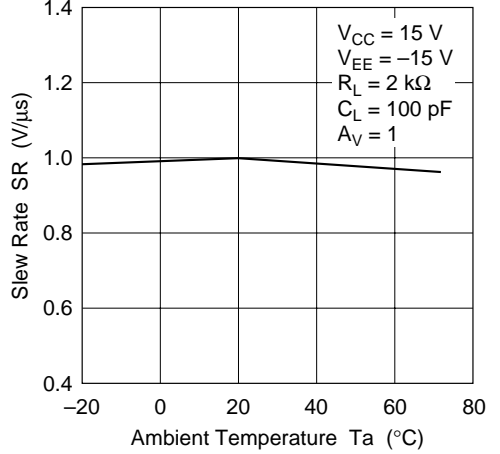

Output Short Current vs. Ambient Temperature

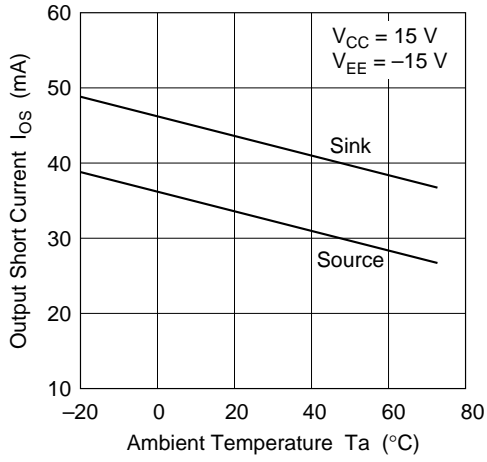

Input Noise Voltage vs. Frequency

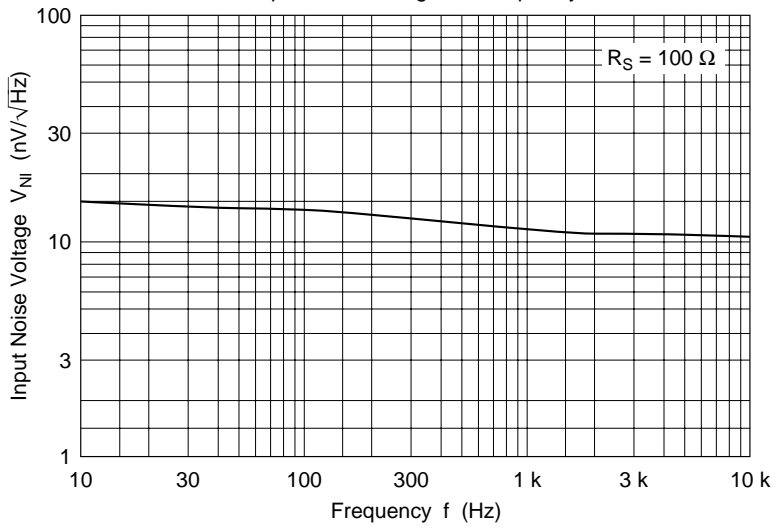

Input Offset Voltage vs. Ambient Temperature

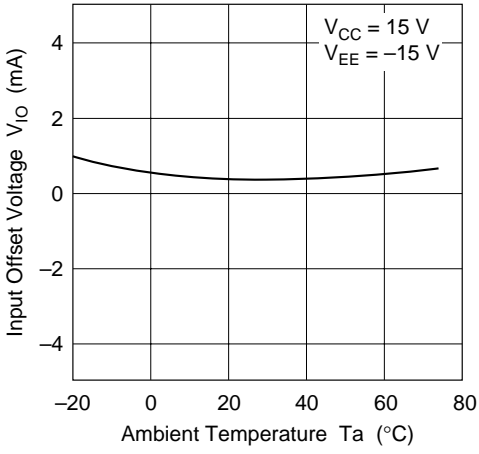

Common-mode Rejection Ratio vs. Ambient Temperature

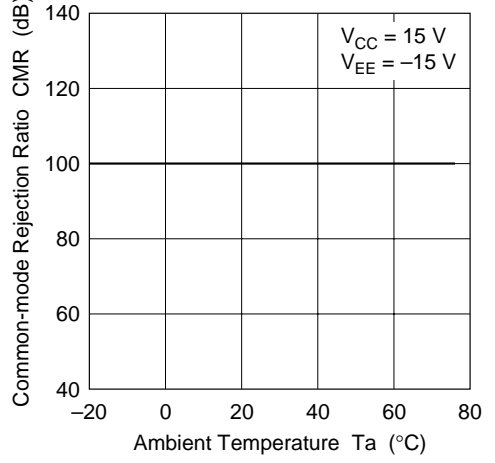

Circuit Example

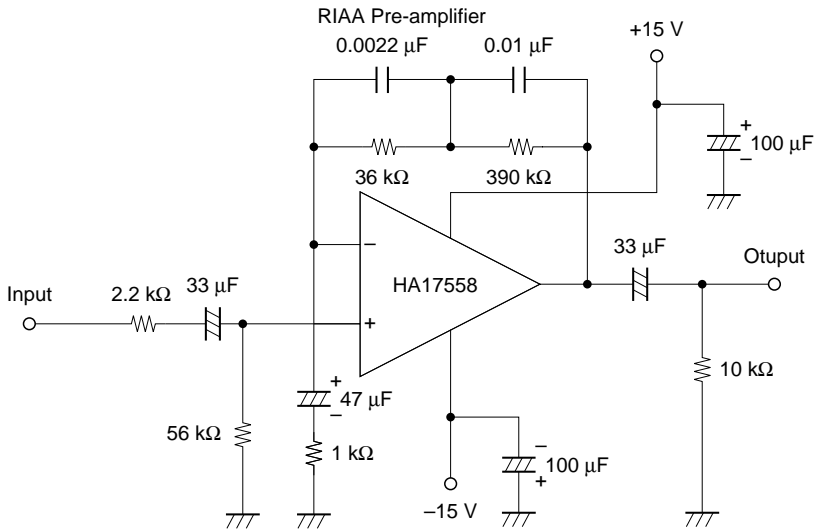

T.H.D. vs. Output Voltage (RIAA Pre-Amp)

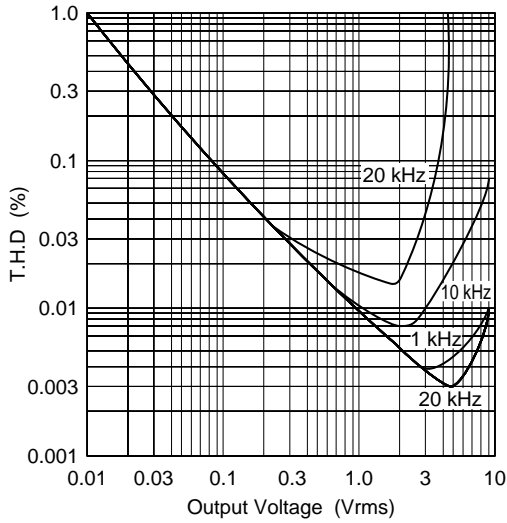

T.H.D. vs. Output Voltage (RIAA Pre-Amp)

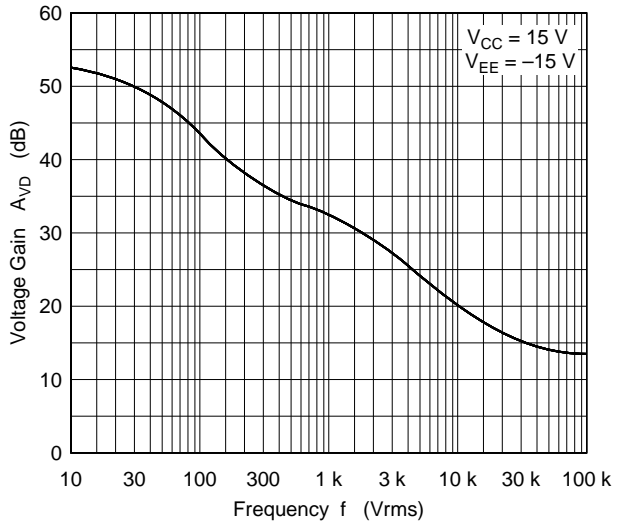

Package Dimensions

Unit: mm

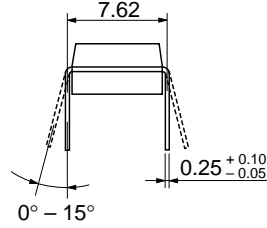
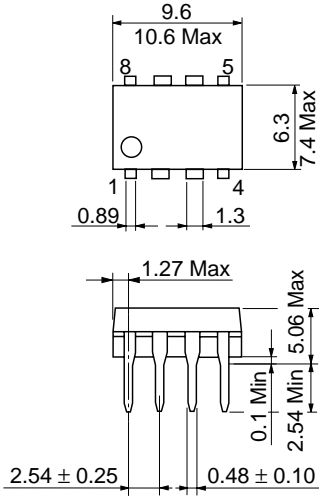

Hitachi Code	DP-8
JEDEC	Conforms
EIAJ	Conforms
Mass (reference value)	0.54 g

Unit: mm

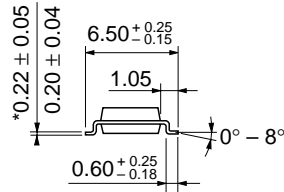
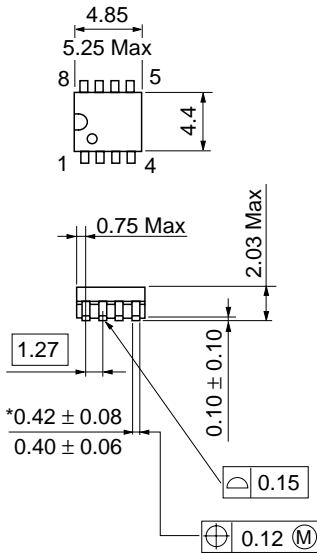

Hitachi Code	FP-8D
JEDEC	—
EIAJ	Conforms
Mass (reference value)	0.10 g

*Dimension including the plating thickness
Base material dimension

Cautions

1. Hitachi neither warrants nor grants licenses of any rights of Hitachi's or any third party's patent, copyright, trademark, or other intellectual property rights for information contained in this document. Hitachi bears no responsibility for problems that may arise with third party's rights, including intellectual property rights, in connection with use of the information contained in this document.
2. Products and product specifications may be subject to change without notice. Confirm that you have received the latest product standards or specifications before final design, purchase or use.
3. Hitachi makes every attempt to ensure that its products are of high quality and reliability. However, contact Hitachi's sales office before using the product in an application that demands especially high quality and reliability or where its failure or malfunction may directly threaten human life or cause risk of bodily injury, such as aerospace, aeronautics, nuclear power, combustion control, transportation, traffic, safety equipment or medical equipment for life support.
4. Design your application so that the product is used within the ranges guaranteed by Hitachi particularly for maximum rating, operating supply voltage range, heat radiation characteristics, installation conditions and other characteristics. Hitachi bears no responsibility for failure or damage when used beyond the guaranteed ranges. Even within the guaranteed ranges, consider normally foreseeable failure rates or failure modes in semiconductor devices and employ systemic measures such as fail-safes, so that the equipment incorporating Hitachi product does not cause bodily injury, fire or other consequential damage due to operation of the Hitachi product.
5. This product is not designed to be radiation resistant.
6. No one is permitted to reproduce or duplicate, in any form, the whole or part of this document without written approval from Hitachi.
7. Contact Hitachi's sales office for any questions regarding this document or Hitachi semiconductor products.

HITACHI

Hitachi, Ltd.

Semiconductor & Integrated Circuits.
Nippon Bldg., 2-6-2, Ohite-machi, Chiyoda-ku, Tokyo 100-0004, Japan
Tel: Tokyo (03) 3270-2111 Fax: (03) 3270-5109

URL NorthAmerica : <http://semiconductor.hitachi.com/>
 Europe : <http://www.hitachi-eu.com/hel/ecg>
 Asia (Singapore) : <http://www.has.hitachi.com.sg/grp3/sicd/index.htm>
 Asia (Taiwan) : http://www.hitachi.com.tw/E/Product/SICD_Frame.htm
 Asia (HongKong) : <http://www.hitachi.com.hk/eng/bo/grp3/index.htm>
 Japan : <http://www.hitachi.co.jp/Sicd/indx.htm>

For further information write to:

Hitachi Semiconductor
(America) Inc.
179 East Tasman Drive,
San Jose, CA 95134
Tel: <1> (408) 433-1990
Fax: <1> (408) 433-0223

Hitachi Europe GmbH
Electronic components Group
Dornacher Straße 3
D-85622 Feldkirchen, Munich
Germany
Tel: <49> (89) 9 9180-0
Fax: <49> (89) 9 29 30 00

Hitachi Europe Ltd.
Electronic Components Group.
Whitebrook Park
Lower Cookham Road
Maidenhead
Berkshire SL6 8YA, United Kingdom
Tel: <44> (1628) 585000
Fax: <44> (1628) 778322

Hitachi Asia Pte. Ltd.
16 Collyer Quay #20-00
Hitachi Tower
Singapore 049318
Tel: 535-2100
Fax: 535-1533

Hitachi Asia Ltd.
Taipei Branch Office
3F, Hung Kuo Building, No.167,
Tun-Hwa North Road, Taipei (105)
Tel: <886> (2) 2718-3666
Fax: <886> (2) 2718-8180

Hitachi Asia (Hong Kong) Ltd.
Group III (Electronic Components)
7/F., North Tower, World Finance Centre,
Harbour City, Canton Road, Tsim Sha Tsui,
Kowloon, Hong Kong
Tel: <852> (2) 735 9218
Fax: <852> (2) 730 0281
Telex: 40815 HITEC HX

Copyright ' Hitachi, Ltd., 1998. All rights reserved. Printed in Japan.

HITACHI