

SN54LS682, SN54LS684, SN54LS685, SN54LS687, SN54LS688, SN74LS682, SN74LS684 THRU SN74LS688 8-BIT MAGNITUDE/IDENTITY COMPARATORS

D2617, JANUARY 1981—REVISED MARCH 1988

SDLS008

- Compares Two-8-Bit Words
- Choice of Totem-Pole or Open-Collector Outputs
- Hysteresis at P and Q Inputs
- 'LS682 has 20-kΩ Pullup Resistors on the Q Inputs
- SN74LS686 and 'LS687 . . . JT and NT 24-Pin, 300-Mil Packages

SN54LS682, SN54LS684, SN54LS685 . . . J PACKAGE
SN74LS682, SN74LS684, SN74LS685 . . . DW OR N PACKAGE

(TOP VIEW)

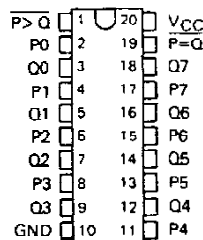

TYPE	P = Q	P > Q	OUTPUT ENABLE	OUTPUT CONFIGURATION	20-kΩ PULLUP
'LS682	yes	yes	no	totem-pole	yes
'LS684	yes	yes	no	totem-pole	no
'LS685	yes	yes	no	open-collector	no
SN74LS686	yes	yes	yes	totem-pole	no
'LS687	yes	yes	yes	open-collector	no
'LS688	yes	no	yes	totem-pole	no

SN54LS682, SN54LS684, SN54LS685 . . . FK PACKAGE

(TOP VIEW)

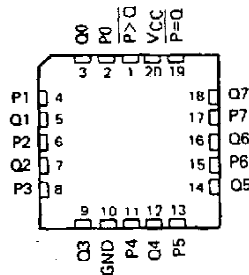

SN54LS687 . . . JT PACKAGE
SN74LS686, SN74LS687 . . . DW OR NT PACKAGE

(TOP VIEW)

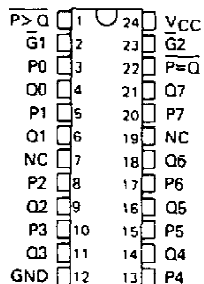

SN54LS687 . . . FK PACKAGE

(TOP VIEW)

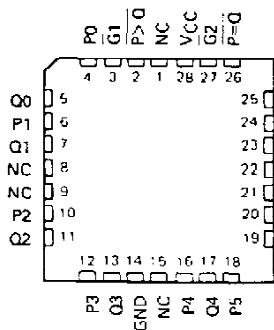

NC—No internal connection

SN54LS688 . . . J PACKAGE
SN74LS688 . . . DW OR N PACKAGE

(TOP VIEW)

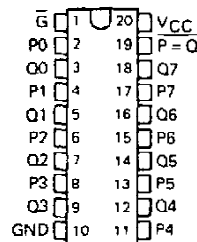

SN54LS688 . . . FK PACKAGE

(TOP VIEW)

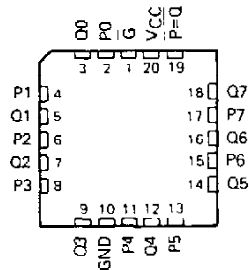

PRODUCTION DATA documents contain information current as of publication date. Products conform to specifications per the terms of Texas Instruments standard warranty. Production processing does not necessarily include testing of all parameters.

TEXAS
INSTRUMENTS

POST OFFICE BOX 655012 • DALLAS, TEXAS 75265

SN54LS682, SN54LS684, SN54LS685, SN54LS687, SN54LS688 SN74LS682, SN74LS684 THRU SN74LS688 8-BIT MAGNITUDE/IDENTITY COMPARATORS

description

These magnitude comparators perform comparisons of two eight-bit binary or BCD words. All types provide $\overline{P=Q}$ outputs and all except 'LS688 provide $\overline{P>Q}$ outputs as well. The 'LS682, 'LS684, 'LS686, and 'LS688 have totem-pole outputs, while the 'LS685 and 'LS687 have open-collector outputs. The 'LS682 features 20-k Ω pullup termination resistors on the Q inputs for analog or switch data.

FUNCTION TABLE

DATA P, Q	ENABLES		OUTPUTS	
	$\overline{G1}$, $\overline{G1}$	$\overline{G2}$	$\overline{P=Q}$	$\overline{P>Q}$
P=Q	L	X	L	H
P>Q	X	L	H	L
P<Q	X	X	H	H
P=Q	H	X	H	H
P>Q	X	H	H	H
X	H	H	H	H

- NOTES: 1. The last three lines of the function table applies only to the devices having enable inputs, i.e., 'LS686 thru 'LS688.
2. The $\overline{P<Q}$ function can be generated by applying the $\overline{P=Q}$ and $\overline{P>Q}$ outputs to a 2-input NAND gate.
3. For 'LS686 and 'LS687, $\overline{G1}$ enables $\overline{P=Q}$ and $\overline{G2}$ enables $\overline{P>Q}$.

logic symbols†



†These symbols are in accordance with ANSI/IEEE Std 91-1984 and IEC Publication 617-12. Pin numbers shown are for DW, J, JT, N, and NT packages.

**SN54LS682, SN54LS684, SN54LS685, SN54LS687, SN54LS688,
SN74LS682, SN74LS684 THRU SN74LS688
8-BIT MAGNITUDE/IDENTITY COMPARATORS**

logic symbols† (continued)



†These symbols are in accordance with ANSI/IEEE Std 91-1984 and IEC Publication 617-12. Pin numbers shown are for DW, J, JT, N, and NT packages.

schematics of inputs and outputs



**SN54LS682, SN54LS684, SN54LS685
 SN74LS682, SN74LS684, SN74LS685
 8-BIT MAGNITUDE/IDENTITY COMPARATORS**

LS682, LS684, LS685 logic diagram (positive logic)

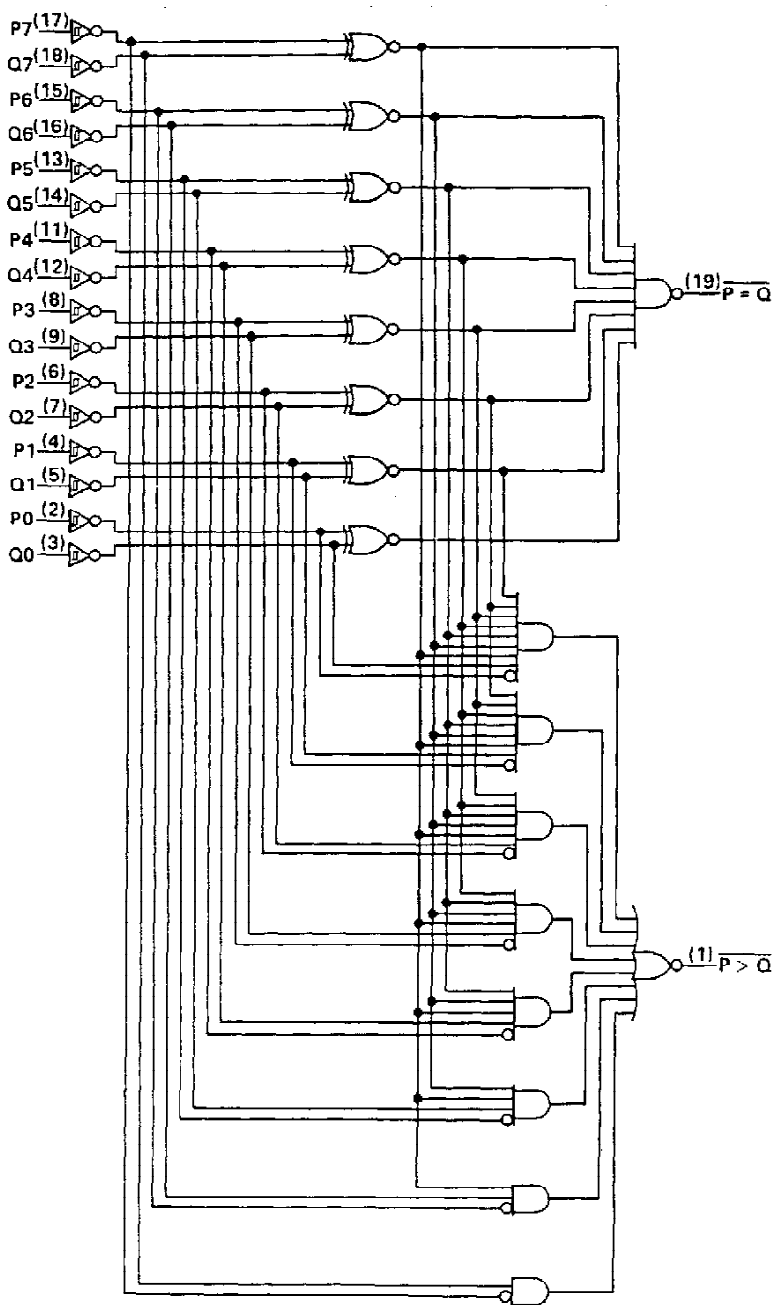

Pin numbers shown are for DW, J, and N packages.

TEXAS 
INSTRUMENTS

POST OFFICE BOX 655012 • DALLAS, TEXAS 75265

SN54LS687
SN74LS686, SN74LS687
8-BIT MAGNITUDE/IDENTITY COMPARATORS

'LS686, 'LS687 logic diagram (positive logic)



Pin numbers shown are for DW, JT, and NT packages.

TEXAS
INSTRUMENTS

POST OFFICE BOX 655012 • DALLAS, TEXAS 75265

**SN54LS682, SN54LS684, SN54LS685, SN54LS687, SN54LS688
SN74LS682, SN74LS684 THRU SN74LS688
8-BIT IDENTITY COMPARATORS**

'LS688 logic diagram (positive logic)



Pin numbers shown are for DW, J, and N packages.

absolute maximum ratings over operating free-air temperature range (unless otherwise noted)

Supply voltage, V_{CC} (see Note 1)	7 V
Input voltage: Q inputs of 'LS682	5.5 V
All other inputs	7 V
Off-state output voltage: 'LS685, 'LS687	7 V
Operating free-air temperature range:	
SN54LS682, SN54LS684, SN54LS685, SN54LS687, SN54LS688	-55 °C to 125 °C
SN74LS682, SN74LS684 thru SN74LS688	0 °C to 70 °C
Storage temperature range	-65 °C to 150 °C

NOTE 1: Voltage values are with respect to network ground terminal.

**SN54LS682, SN54LS684, SN54LS688
SN74LS682, SN74LS684, SN74LS686, SN74LS688
8-BIT MAGNITUDE/IDENTITY COMPARATORS WITH TOTEM-POLE OUTPUTS**

recommended operating conditions

	SN54LS'			SN74LS'			UNIT
	MIN	NOM	MAX	MIN	NOM	MAX	
Supply voltage, V_{CC}	4.5	5	5.5	4.85	5	5.25	V
High-level output current, I_{OH}			-400			-400	μ A
Low-level output current, I_{OL}			12			24	mA
Operating free-air temperature, T_A	-55		125	0		70	$^{\circ}$ C

electrical characteristics over recommended operating free-air temperature range (unless otherwise noted)

PARAMETER		TEST CONDITIONS†	SN54LS'			SN74LS'			UNIT
			MIN	TYP‡	MAX	MIN	TYP‡	MAX	
V_{IH}	High-level input voltage		2			2			V
V_{IL}	Low-level input voltage				0.7			0.8	V
$V_{T+} - V_{T-}$	Hysteresis	P or Q inputs	0.4			0.4			V
V_{IK}	Input clamp voltage	$V_{CC} = \text{MIN}$	-1.5			-1.5			V
V_{OH}	High-level output voltage	$V_{CC} = \text{MIN}$, $V_{IH} = 2 \text{ V}$, $V_{IL} = V_{IL\text{max}}$, $I_{OH} = -400 \mu\text{A}$	2.5			2.7			V
V_{OL}	Low-level output voltage	$V_{CC} = \text{MIN}$, $V_{IH} = 2 \text{ V}$, $V_{IL} = V_{IL\text{max}}$	$I_{OL} = 12 \text{ mA}$		0.25	0.4		V	
			$I_{OL} = 24 \text{ mA}$			0.35 0.5			
I_I	Input current at maximum input voltage	Q inputs, 'LS682	$V_{CC} = \text{MAX}$, $V_I = 5.5 \text{ V}$			0.1			mA
		All other inputs	$V_{CC} = \text{MAX}$, $V_I = 7 \text{ V}$						
I_{IH}	High-level input current		$V_{CC} = \text{MAX}$, $V_I = 2.7 \text{ V}$			20			μ A
I_{IL}	Low-level input current	Q inputs, 'LS682	$V_{CC} = \text{MAX}$, $V_I = 0.4 \text{ V}$			-0.4			mA
		All other inputs				-0.2			
I_{OS}^{\S}	Short-circuit output current	$V_{CC} = \text{MAX}$, $V_O = 0$	-20	-100		-20	-100		mA
I_{CC}	Supply current	'LS682	$V_{CC} = \text{MAX}$, See Note 1			42	70		mA
		'LS684				40	65		
		'LS686				44	75		
		'LS688				40	65		

† For conditions shown as MIN or MAX, use the appropriate values specified under recommended operating conditions.

‡ All typical values are at $V_{CC} = 5 \text{ V}$, $T_A = 25^{\circ}\text{C}$.

§ Not more than one output should be shorted at a time, and duration of the short-circuit should not exceed one second.

NOTE 1: I_{CC} is measured with any \bar{Q} inputs grounded, all other inputs at 4.5 V, and all outputs open.

TEXAS
INSTRUMENTS

POST OFFICE BOX 655012 • DALLAS, TEXAS 75265

SN54LS682, SN54LS684, SN54LS688
SN74LS682, SN74LS684, SN74LS686, SN74LS688
8-BIT MAGNITUDE/IDENTITY COMPARATORS WITH TOTEM-POLE OUTPUTS

switching characteristics, $V_{CC} = 5\text{ V}$, $T_A = 25^\circ\text{C}$

PARAMETER†	FROM (INPUTS)	TO (OUTPUT)	TEST CONDITIONS	'LS682		'LS684		'LS686		'LS688		UNIT
				MIN	TYP MAX	MIN	TYP MAX	MIN	TYP MAX	MIN	TYP MAX	
t_{PLH}	P	$\overline{P} = \overline{Q}$	$R_L = 667\ \Omega$, $C_L = 45\ \text{pF}$, All other inputs low, See Note 2	13	25	15	25	13	25	12	18	ns
t_{PHL}				15	25	17	25	20	30	17	23	
t_{PLH}	Q	$\overline{P} = \overline{Q}$		14	25	16	25	13	25	12	18	ns
t_{PHL}				15	25	15	25	21	30	17	23	
t_{PLH}	$\overline{Q}, \overline{Q}1$	$\overline{P} = \overline{Q}$						11	20	12	18	ns
t_{PHL}								19	30	13	20	
t_{PLH}	P	$\overline{P} > \overline{Q}$			20	30	22	30	19	30		ns
t_{PHL}					15	30	17	30	15	30		
t_{PLH}	Q	$\overline{P} > \overline{Q}$			21	30	24	30	18	30		ns
t_{PHL}					19	30	20	30	19	30		
t_{PLH}	$\overline{Q}2$	$\overline{P} > \overline{Q}$						21	30		ns	
t_{PHL}								16	25			

† t_{PLH} = propagation delay time, low-to-high-level outputs; t_{PHL} = propagation delay time, high-to-low-level output.
 NOTE 2: Load circuits and voltage waveforms are shown in Section 1.

SN54LS685, SN54LS687
SN74LS685, SN74LS687, SN74LS688

8-BIT MAGNITUDE/IDENTITY COMPARATORS WITH TOTEM-POLE OUTPUTS

recommended operating conditions

	SN54LS [†]			SN74LS [†]			UNIT
	MIN	NOM	MAX	MIN	NOM	MAX	
Supply voltage, V_{CC}	4.5	5	5.5	4.85	5	5.25	V
High-level output current, I_{OH}			5.5			5.5	V
Low-level output current, I_{OL}			12			24	mA
Operating free-air temperature, T_A	-55		125	0		70	°C

electrical characteristics over recommended operating free-air temperature range (unless otherwise noted)

PARAMETER		TEST CONDITIONS [†]	SN54LS [†]			SN74LS [†]			UNIT	
			MIN	TYP	MAX	MIN	TYP	MAX		
V_{IH}	High-level input voltage		2			2			V	
V_{IL}	Low-level input voltage				0.7			0.8	V	
$V_{T+} - V_{T-}$	Hysteresis	P or Q inputs	0.4			0.4			V	
V_{IK}	Input clamp voltage	$V_{CC} = \text{MIN}, I_I = -18 \text{ mA}$			-1.5			-1.5	V	
I_{OH}	High-level output voltage	$V_{CC} = \text{MIN}, V_{IH} = 2 \text{ V}, V_{IL} = V_{ILmax}, V_{OH} = 5.5 \text{ V}$			250			100	μA	
V_{OL}	Low-level output voltage	$V_{CC} = \text{MIN}, V_{IH} = 2 \text{ V}, V_{IL} = V_{ILmax}, I_{OL} = 12 \text{ mA}$		0.25	0.4		0.25	0.4	V	
		$V_{CC} = \text{MIN}, V_{IH} = 2 \text{ V}, V_{IL} = V_{ILmax}, I_{OL} = 24 \text{ mA}$					0.35	0.5		
I_I		$V_{CC} = \text{MAX}, V_I = 7 \text{ V}$			0.1			0.1	mA	
I_{IH}	High-level input current	$V_{CC} = \text{MAX}, V_I = 2.7 \text{ V}$			20			20	μA	
I_{IL}	Low-level input current	$V_{CC} = \text{MAX}, V_I = 0.4 \text{ V}$			-0.2			-0.2	mA	
I_{CC}	Supply current	'LS685	$V_{CC} = \text{MAX}, \text{ See Note 1}$			40	65	40	65	mA
		'LS687				44	75	44	75	

[†]For conditions shown as MIN or MAX, use the appropriate values specified under recommended operating conditions.

[‡]All typical values are at $V_{CC} = 5 \text{ V}, T_A = 25^\circ\text{C}$.

NOTE 1: I_{CC} is measure with any \bar{Q} inputs grounded, all other inputs at 4.5 V, and all outputs open.



SN54LS685, SN54LS687
SN74LS685, SN74LS687
8-BIT MAGNITUDE/IDENTITY COMPARATORS WITH OPEN-COLLECTOR OUTPUTS

switching characteristics, $V_{CC} = 5\text{ V}$, $T_A = 25^\circ\text{C}$

PARAMETER	FROM (INPUT)	TO (OUTPUT)	TEST CONDITIONS	'LS685			'LS687			UNIT
				MIN	TYP	MAX	MIN	TYP	MAX	
t_{PLH}	P	$\overline{P=Q}$	$R_L = 667\ \Omega$, $C_L = 45\ \text{pF}$, All other inputs low, See Note 2	30	45		24	35	ns	
t_{PHL}				19	35		20	30		
t_{PLH}	Q	$\overline{P=Q}$		24	45		24	35	ns	
t_{PHL}				23	35		20	30		
t_{PLH}	$\overline{Q}, \overline{Q1}$	$\overline{P=Q}$					21	35	ns	
t_{PHL}							18	30		
t_{PLH}	P	$\overline{P>Q}$			32	45		24	35	ns
t_{PHL}					16	35		16	30	
t_{PLH}	Q	$\overline{P>Q}$			30	45		24	35	ns
t_{PHL}					20	35		16	30	
t_{PLH}	$\overline{Q2}$	$\overline{P>Q}$				24	35	ns		
t_{PHL}						15	30			

t_{PLH} = propagation delay time, low-to-high-level outputs; t_{PHL} = propagation delay time, high-to-low-level output.
 NOTE 2: Load circuits and voltage waveforms are shown in Section 1.

IMPORTANT NOTICE

Texas Instruments (TI) reserves the right to make changes to its products or to discontinue any semiconductor product or service without notice, and advises its customers to obtain the latest version of relevant information to verify, before placing orders, that the information being relied on is current.

TI warrants performance of its semiconductor products and related software to the specifications applicable at the time of sale in accordance with TI's standard warranty. Testing and other quality control techniques are utilized to the extent TI deems necessary to support this warranty. Specific testing of all parameters of each device is not necessarily performed, except those mandated by government requirements.

Certain applications using semiconductor products may involve potential risks of death, personal injury, or severe property or environmental damage ("Critical Applications").

TI SEMICONDUCTOR PRODUCTS ARE NOT DESIGNED, INTENDED, AUTHORIZED, OR WARRANTED TO BE SUITABLE FOR USE IN LIFE-SUPPORT APPLICATIONS, DEVICES OR SYSTEMS OR OTHER CRITICAL APPLICATIONS.

Inclusion of TI products in such applications is understood to be fully at the risk of the customer. Use of TI products in such applications requires the written approval of an appropriate TI officer. Questions concerning potential risk applications should be directed to TI through a local SC sales office.

In order to minimize risks associated with the customer's applications, adequate design and operating safeguards should be provided by the customer to minimize inherent or procedural hazards.

TI assumes no liability for applications assistance, customer product design, software performance, or infringement of patents or services described herein. Nor does TI warrant or represent that any license, either express or implied, is granted under any patent right, copyright, mask work right, or other intellectual property right of TI covering or relating to any combination, machine, or process in which such semiconductor products or services might be or are used.

PACKAGING INFORMATION

Orderable Device	Status ⁽¹⁾	Package Type	Package Drawing	Pins	Package Qty	Eco Plan ⁽²⁾	Lead/Ball Finish	MSL Peak Temp ⁽³⁾
84151012A	ACTIVE	LCCC	FK	20	1	TBD	POST-PLATE	N / A for Pkg Type
8415101RA	ACTIVE	CDIP	J	20	1	TBD	A42 SNPB	N / A for Pkg Type
8415101RA	ACTIVE	CDIP	J	20	1	TBD	A42 SNPB	N / A for Pkg Type
8415101SA	ACTIVE	CFP	W	20	1	TBD	A42	N / A for Pkg Type
8415101SA	ACTIVE	CFP	W	20	1	TBD	A42	N / A for Pkg Type
84152012A	ACTIVE	LCCC	FK	20	1	TBD	POST-PLATE	N / A for Pkg Type
8415201RA	ACTIVE	CDIP	J	20	1	TBD	A42 SNPB	N / A for Pkg Type
8415201SA	ACTIVE	CFP	W	20	1	TBD	A42	N / A for Pkg Type
84153012A	ACTIVE	LCCC	FK	20	1	TBD	POST-PLATE	N / A for Pkg Type
8415301RA	ACTIVE	CDIP	J	20	1	TBD	A42 SNPB	N / A for Pkg Type
8415301SA	ACTIVE	CFP	W	20	1	TBD	A42	N / A for Pkg Type
SN54LS682J	ACTIVE	CDIP	J	20	1	TBD	A42 SNPB	N / A for Pkg Type
SN54LS682J	ACTIVE	CDIP	J	20	1	TBD	A42 SNPB	N / A for Pkg Type
SN54LS684J	ACTIVE	CDIP	J	20	1	TBD	A42 SNPB	N / A for Pkg Type
SN54LS688J	ACTIVE	CDIP	J	20	1	TBD	A42 SNPB	N / A for Pkg Type
SN74LS682DW	ACTIVE	SOIC	DW	20	25	Green (RoHS & no Sb/Br)	CU NIPDAU	Level-1-260C-UNLIM
SN74LS682DW	ACTIVE	SOIC	DW	20	25	Green (RoHS & no Sb/Br)	CU NIPDAU	Level-1-260C-UNLIM
SN74LS682DWE4	ACTIVE	SOIC	DW	20	25	Green (RoHS & no Sb/Br)	CU NIPDAU	Level-1-260C-UNLIM
SN74LS682DWE4	ACTIVE	SOIC	DW	20	25	Green (RoHS & no Sb/Br)	CU NIPDAU	Level-1-260C-UNLIM
SN74LS682DWR	ACTIVE	SOIC	DW	20	2000	Green (RoHS & no Sb/Br)	CU NIPDAU	Level-1-260C-UNLIM
SN74LS682DWR	ACTIVE	SOIC	DW	20	2000	Green (RoHS & no Sb/Br)	CU NIPDAU	Level-1-260C-UNLIM
SN74LS682DWRE4	ACTIVE	SOIC	DW	20	2000	Green (RoHS & no Sb/Br)	CU NIPDAU	Level-1-260C-UNLIM
SN74LS682DWRE4	ACTIVE	SOIC	DW	20	2000	Green (RoHS & no Sb/Br)	CU NIPDAU	Level-1-260C-UNLIM
SN74LS682N	ACTIVE	PDIP	N	20	20	Pb-Free (RoHS)	CU NIPDAU	N / A for Pkg Type
SN74LS682N	ACTIVE	PDIP	N	20	20	Pb-Free (RoHS)	CU NIPDAU	N / A for Pkg Type
SN74LS682NE4	ACTIVE	PDIP	N	20	20	Pb-Free (RoHS)	CU NIPDAU	N / A for Pkg Type
SN74LS682NE4	ACTIVE	PDIP	N	20	20	Pb-Free (RoHS)	CU NIPDAU	N / A for Pkg Type
SN74LS682NSR	ACTIVE	SO	NS	20	2000	Green (RoHS & no Sb/Br)	CU NIPDAU	Level-1-260C-UNLIM
SN74LS682NSR	ACTIVE	SO	NS	20	2000	Green (RoHS & no Sb/Br)	CU NIPDAU	Level-1-260C-UNLIM
SN74LS682NSRE4	ACTIVE	SO	NS	20	2000	Green (RoHS & no Sb/Br)	CU NIPDAU	Level-1-260C-UNLIM
SN74LS682NSRE4	ACTIVE	SO	NS	20	2000	Green (RoHS & no Sb/Br)	CU NIPDAU	Level-1-260C-UNLIM

Orderable Device	Status ⁽¹⁾	Package Type	Package Drawing	Pins	Package Qty	Eco Plan ⁽²⁾	Lead/Ball Finish	MSL Peak Temp ⁽³⁾
SN74LS684DW	ACTIVE	SOIC	DW	20	25	Green (RoHS & no Sb/Br)	CU NIPDAU	Level-1-260C-UNLIM
SN74LS684DWE4	ACTIVE	SOIC	DW	20	25	Green (RoHS & no Sb/Br)	CU NIPDAU	Level-1-260C-UNLIM
SN74LS684DWR	ACTIVE	SOIC	DW	20	2000	Green (RoHS & no Sb/Br)	CU NIPDAU	Level-1-260C-UNLIM
SN74LS684DWRE4	ACTIVE	SOIC	DW	20	2000	Green (RoHS & no Sb/Br)	CU NIPDAU	Level-1-260C-UNLIM
SN74LS684N	ACTIVE	PDIP	N	20	20	Pb-Free (RoHS)	CU NIPDAU	N / A for Pkg Type
SN74LS684NE4	ACTIVE	PDIP	N	20	20	Pb-Free (RoHS)	CU NIPDAU	N / A for Pkg Type
SN74LS684NSR	ACTIVE	SO	NS	20	2000	Green (RoHS & no Sb/Br)	CU NIPDAU	Level-1-260C-UNLIM
SN74LS684NSRE4	ACTIVE	SO	NS	20	2000	Green (RoHS & no Sb/Br)	CU NIPDAU	Level-1-260C-UNLIM
SN74LS686DW	OBSOLETE	SOIC	DW	24		TBD	Call TI	Call TI
SN74LS686NT	OBSOLETE	PDIP	NT	24		TBD	Call TI	Call TI
SN74LS687NT	OBSOLETE	PDIP	NT	24		TBD	Call TI	Call TI
SN74LS687NT	OBSOLETE	PDIP	NT	24		TBD	Call TI	Call TI
SN74LS688DW	ACTIVE	SOIC	DW	20	25	Green (RoHS & no Sb/Br)	CU NIPDAU	Level-1-260C-UNLIM
SN74LS688DWE4	ACTIVE	SOIC	DW	20	25	Green (RoHS & no Sb/Br)	CU NIPDAU	Level-1-260C-UNLIM
SN74LS688DWR	ACTIVE	SOIC	DW	20	2000	Green (RoHS & no Sb/Br)	CU NIPDAU	Level-1-260C-UNLIM
SN74LS688DWRE4	ACTIVE	SOIC	DW	20	2000	Green (RoHS & no Sb/Br)	CU NIPDAU	Level-1-260C-UNLIM
SN74LS688N	ACTIVE	PDIP	N	20	20	Pb-Free (RoHS)	CU NIPDAU	N / A for Pkg Type
SN74LS688N3	OBSOLETE	PDIP	N	20		TBD	Call TI	Call TI
SN74LS688NE4	ACTIVE	PDIP	N	20	20	Pb-Free (RoHS)	CU NIPDAU	N / A for Pkg Type
SN74LS688NSR	ACTIVE	SO	NS	20	2000	Green (RoHS & no Sb/Br)	CU NIPDAU	Level-1-260C-UNLIM
SN74LS688NSRE4	ACTIVE	SO	NS	20	2000	Green (RoHS & no Sb/Br)	CU NIPDAU	Level-1-260C-UNLIM
SNJ54LS682FK	ACTIVE	LCCC	FK	20	1	TBD	POST-PLATE	N / A for Pkg Type
SNJ54LS682FK	ACTIVE	LCCC	FK	20	1	TBD	POST-PLATE	N / A for Pkg Type
SNJ54LS682J	ACTIVE	CDIP	J	20	1	TBD	A42 SNPB	N / A for Pkg Type
SNJ54LS682J	ACTIVE	CDIP	J	20	1	TBD	A42 SNPB	N / A for Pkg Type
SNJ54LS682W	ACTIVE	CFP	W	20	1	TBD	A42	N / A for Pkg Type
SNJ54LS682W	ACTIVE	CFP	W	20	1	TBD	A42	N / A for Pkg Type
SNJ54LS684FK	ACTIVE	LCCC	FK	20	1	TBD	POST-PLATE	N / A for Pkg Type
SNJ54LS684J	ACTIVE	CDIP	J	20	1	TBD	A42 SNPB	N / A for Pkg Type
SNJ54LS684W	ACTIVE	CFP	W	20	1	TBD	A42	N / A for Pkg Type
SNJ54LS688FK	ACTIVE	LCCC	FK	20	1	TBD	POST-PLATE	N / A for Pkg Type
SNJ54LS688J	ACTIVE	CDIP	J	20	1	TBD	A42 SNPB	N / A for Pkg Type

Orderable Device	Status ⁽¹⁾	Package Type	Package Drawing	Pins	Package Qty	Eco Plan ⁽²⁾	Lead/Ball Finish	MSL Peak Temp ⁽³⁾
SNJ54LS688W	ACTIVE	CFP	W	20	1	TBD	A42	N / A for Pkg Type

⁽¹⁾ The marketing status values are defined as follows:

ACTIVE: Product device recommended for new designs.

LIFEBUY: TI has announced that the device will be discontinued, and a lifetime-buy period is in effect.

NRND: Not recommended for new designs. Device is in production to support existing customers, but TI does not recommend using this part in a new design.

PREVIEW: Device has been announced but is not in production. Samples may or may not be available.

OBSOLETE: TI has discontinued the production of the device.

⁽²⁾ Eco Plan - The planned eco-friendly classification: Pb-Free (RoHS), Pb-Free (RoHS Exempt), or Green (RoHS & no Sb/Br) - please check <http://www.ti.com/productcontent> for the latest availability information and additional product content details.

TBD: The Pb-Free/Green conversion plan has not been defined.

Pb-Free (RoHS): TI's terms "Lead-Free" or "Pb-Free" mean semiconductor products that are compatible with the current RoHS requirements for all 6 substances, including the requirement that lead not exceed 0.1% by weight in homogeneous materials. Where designed to be soldered at high temperatures, TI Pb-Free products are suitable for use in specified lead-free processes.

Pb-Free (RoHS Exempt): This component has a RoHS exemption for either 1) lead-based flip-chip solder bumps used between the die and package, or 2) lead-based die adhesive used between the die and leadframe. The component is otherwise considered Pb-Free (RoHS compatible) as defined above.

Green (RoHS & no Sb/Br): TI defines "Green" to mean Pb-Free (RoHS compatible), and free of Bromine (Br) and Antimony (Sb) based flame retardants (Br or Sb do not exceed 0.1% by weight in homogeneous material)

⁽³⁾ MSL, Peak Temp. -- The Moisture Sensitivity Level rating according to the JEDEC industry standard classifications, and peak solder temperature.

Important Information and Disclaimer:The information provided on this page represents TI's knowledge and belief as of the date that it is provided. TI bases its knowledge and belief on information provided by third parties, and makes no representation or warranty as to the accuracy of such information. Efforts are underway to better integrate information from third parties. TI has taken and continues to take reasonable steps to provide representative and accurate information but may not have conducted destructive testing or chemical analysis on incoming materials and chemicals. TI and TI suppliers consider certain information to be proprietary, and thus CAS numbers and other limited information may not be available for release.

In no event shall TI's liability arising out of such information exceed the total purchase price of the TI part(s) at issue in this document sold by TI to Customer on an annual basis.

J (R-GDIP-T**)

14 LEADS SHOWN

CERAMIC DUAL IN-LINE PACKAGE



DIM \ PINS **	14	16	18	20
A	0.300 (7,62) BSC	0.300 (7,62) BSC	0.300 (7,62) BSC	0.300 (7,62) BSC
B MAX	0.785 (19,94)	.840 (21,34)	0.960 (24,38)	1.060 (26,92)
B MIN	—	—	—	—
C MAX	0.300 (7,62)	0.300 (7,62)	0.310 (7,87)	0.300 (7,62)
C MIN	0.245 (6,22)	0.245 (6,22)	0.220 (5,59)	0.245 (6,22)



4040083/F 03/03

- NOTES:
- All linear dimensions are in inches (millimeters).
 - This drawing is subject to change without notice.
 - This package is hermetically sealed with a ceramic lid using glass frit.
 - Index point is provided on cap for terminal identification only on press ceramic glass frit seal only.
 - Falls within MIL STD 1835 GDIP1-T14, GDIP1-T16, GDIP1-T18 and GDIP1-T20.

W (R-GDFP-F20)

CERAMIC DUAL FLATPACK



- NOTES:
- A. All linear dimensions are in inches (millimeters).
 - B. This drawing is subject to change without notice.
 - C. This package can be hermetically sealed with a ceramic lid using glass frit.
 - D. Index point is provided on cap for terminal identification only.
 - E. Falls within Mil-Std 1835 GDFP2-F20

FK (S-CQCC-N**)

LEADLESS CERAMIC CHIP CARRIER

28 TERMINAL SHOWN



- NOTES:
- A. All linear dimensions are in inches (millimeters).
 - B. This drawing is subject to change without notice.
 - C. This package can be hermetically sealed with a metal lid.
 - D. The terminals are gold plated.
 - E. Falls within JEDEC MS-004

N (R-PDIP-T**)

PLASTIC DUAL-IN-LINE PACKAGE

16 PINS SHOWN



4040049/E 12/2002

- NOTES:
- A. All linear dimensions are in inches (millimeters).
 - B. This drawing is subject to change without notice.
 - $\triangle C$ Falls within JEDEC MS-001, except 18 and 20 pin minimum body length (Dim A).
 - $\triangle D$ The 20 pin end lead shoulder width is a vendor option, either half or full width.

NT (R-PDIP-T**)

PLASTIC DUAL-IN-LINE PACKAGE

24 PINS SHOWN



- NOTES: A. All linear dimensions are in inches (millimeters).
 B. This drawing is subject to change without notice.

DW (R-PDSO-G20)

PLASTIC SMALL-OUTLINE PACKAGE



- NOTES:
- A. All linear dimensions are in inches (millimeters).
 - B. This drawing is subject to change without notice.
 - C. Body dimensions do not include mold flash or protrusion not to exceed 0.006 (0,15).
 - D. Falls within JEDEC MS-013 variation AC.

MECHANICAL DATA

NS (R-PDSO-G**)

PLASTIC SMALL-OUTLINE PACKAGE

14-PINS SHOWN



- NOTES:
- A. All linear dimensions are in millimeters.
 - B. This drawing is subject to change without notice.
 - C. Body dimensions do not include mold flash or protrusion, not to exceed 0,15.