

# LAPT 2SA1386/1386A

Silicon PNP Epitaxial Planar Transistor (Complement to type 2SC3519/A)

Application : Audio and General Purpose

**Absolute maximum ratings** (Ta=25°C)

Symbol	2SA1386	2SA1386A	Unit
VcBo	-160	-180	V
VcEO	-160	-180	V
VEBO	-5		V
Ic	-15		A
Ib	-4		A
Pc	130(Tc=25°C)		W
Tj	150		°C
Tstg	-55 to +150		°C

**Electrical Characteristics** (Ta=25°C)

Symbol	Conditions	2SA1386	2SA1386A	Unit
IcBo	VcB=	-100max	-100max	μA
VcEO	VcB=	-160	-180	V
IEBO	VEB=-5V		-100max	μA
V(BR)CEO	Ic=-25mA	-160min	-180min	V
hFE	VCE=-4V, Ic=-5A		50min*	
VCE(sat)	Ic=-5A, Ib=-0.5A		-2.0max	V
fT	VCE=-12V, IE=2A		40typ	MHz
COB	VcB=-10V, f=1MHz		500typ	pF

\*hFE Rank O(50 to 100), P(70 to 140), Y(90 to 180)

**External Dimensions MT-100(TO3P)**

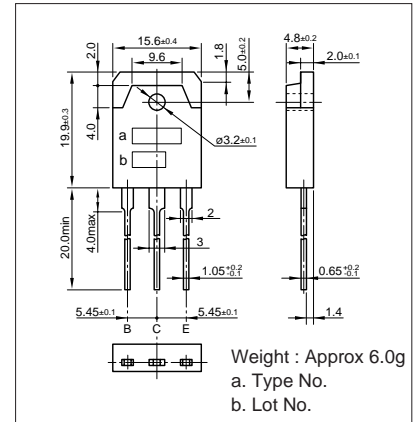

**Typical Switching Characteristics (Common Emitter)**

VCC (V)	RL (Ω)	Ic (A)	VBB1 (V)	VBB2 (V)	IB1 (A)	IB2 (A)	ton (μs)	tstg (μs)	tf (μs)
-40	4	-10	-10	5	-1	1	0.3typ	0.7typ	0.2typ

**Ic-VCE Characteristics (Typical)**

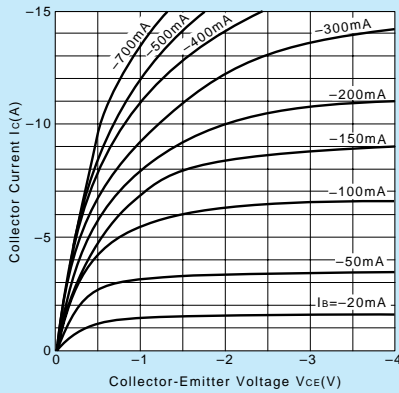

**VCE(sat)-Ib Characteristics (Typical)**

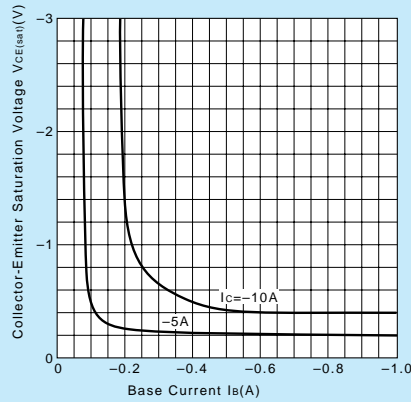

**Ic-VBE Temperature Characteristics (Typical)**

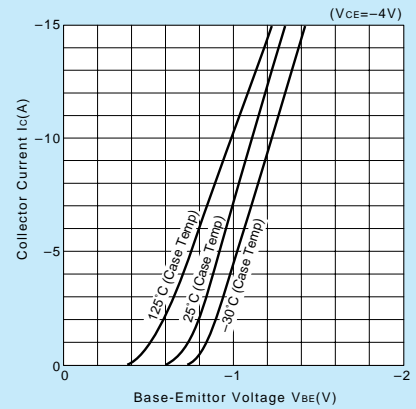

**hFE-Ic Characteristics (Typical)**

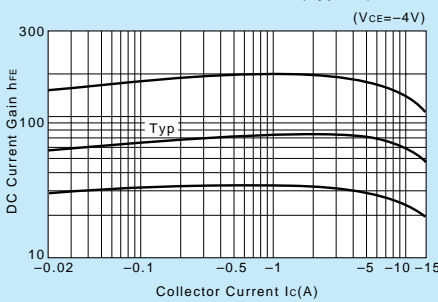

**hFE-Ic Temperature Characteristics (Typical)**

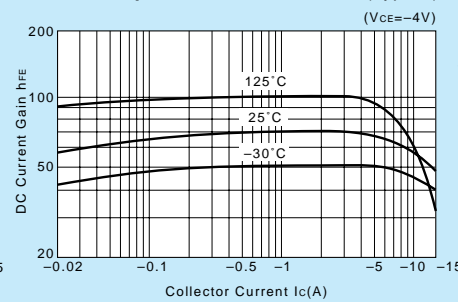

**θj-a-t Characteristics**

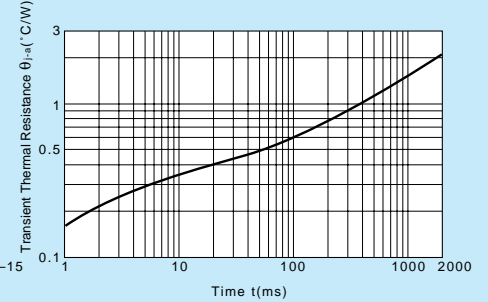

**fT-IE Characteristics (Typical)**

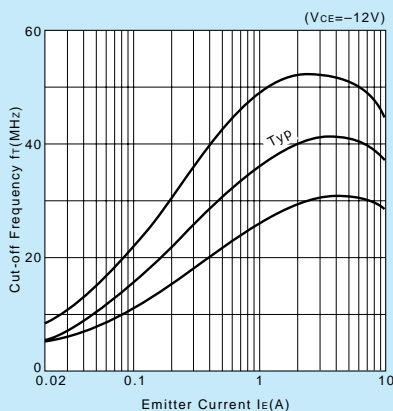

**Safe Operating Area (Single Pulse)**

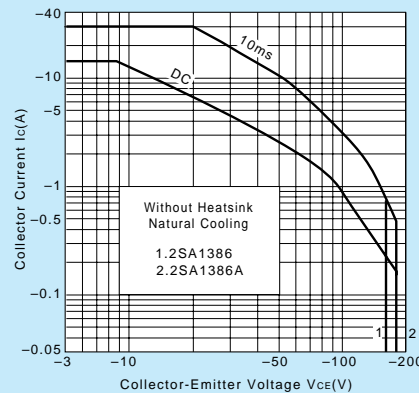

**Pc-Ta Derating**

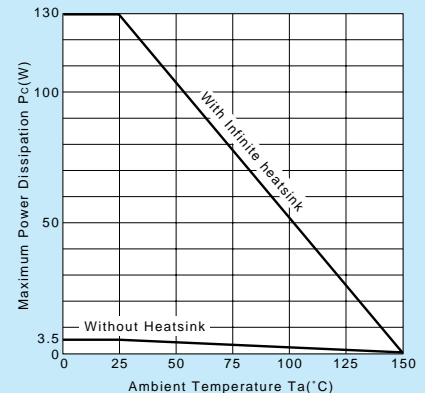

This datasheet has been downloaded from:

[www.DatasheetCatalog.com](http://www.DatasheetCatalog.com)

Datasheets for electronic components.