

2SA1598

(TP7T4)

-7A PNP

OUTLINE DIMENSIONS

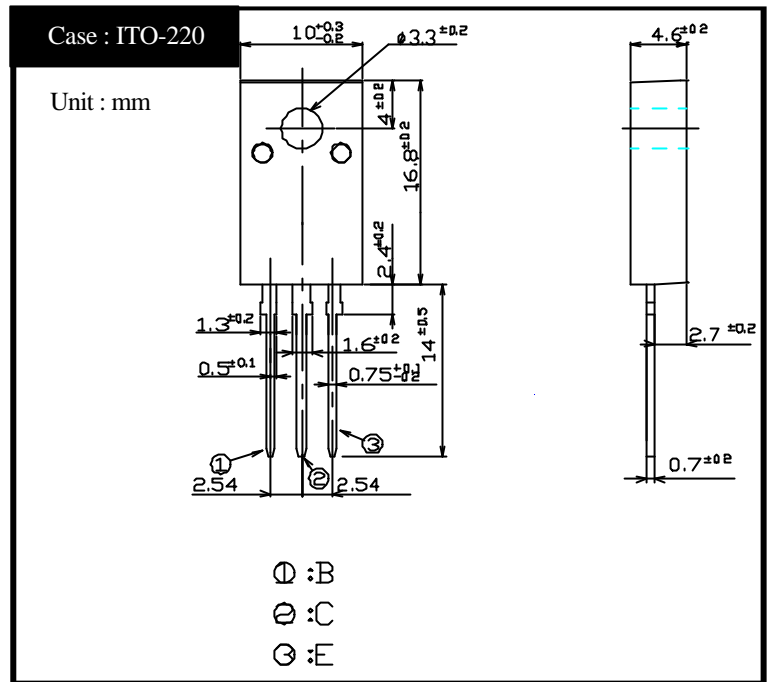

RATINGS

Absolute Maximum Ratings

Item	Symbol	Conditions	Ratings	Unit
Storage Temperature	T _{stg}		-55 ~ 150	
Junction Temperature	T _j		150	
Collector to Base Voltage	V _{CB0}		-60	V
Collector to Emitter Voltage	V _{CE0}		-40	V
Emitter to Base Voltage	V _{EBO}		-7	V
Collector Current DC	I _C		-7	A
Collector Current Peak	I _{CP}		-14	A
Base Current DC	I _B		-1.5	A
Base Current Peak	I _{BP}		-2	A
Total Transistor Dissipation	P _T	T _C = 25	25	W
Dielectric Strength	V _{dis}	Terminal to case, AC 1 minute	2	kV
Mounting Torque	TOR	(Recommended torque : 0.3N·m)	0.5	N·m

Electrical Characteristics (T_c=25)

Item	Symbol	Conditions	Ratings	Unit
Collector to Emitter Sustaining Voltage	V _{CE0(sus)}	I _C = -0.1A	Min -40	V
Collector Cutoff Current	I _{CBO}	At rated Voltage	Max -0.1	mA
			Max -0.1	
Emitter Cutoff Current	I _{EBO}	At rated Voltage	Max -0.1	mA
DC Current Gain	h _{FE}	V _{CE} = -2V, I _C = -3.5A	Min 70	
Collector to Emitter Saturation Voltage	V _{CE(sat)}	I _C = -3.5A	Max -0.3	V
Base to Emitter Saturation Voltage	V _{BE(sat)}	I _B = -0.2A	Max -1.2	V
Thermal Resistance	θ _{JC}	Junction to case	Max 5	/W
Transition Frequency	f _T	V _{CE} = -10V, I _C = -0.7A	TYP 50	MHz
Turn on Time	t _{on}	I _C = -3.5A I _{B1} = -0.35A, I _{B2} = -0.35A R _L = 8 Ω, V _{BB2} = -4V	Max 0.3	μs
Storage Time	t _s		Max 1.5	
Fall Time	t _f		Max 0.5	

2SA1598

$h_{FE} - I_C$

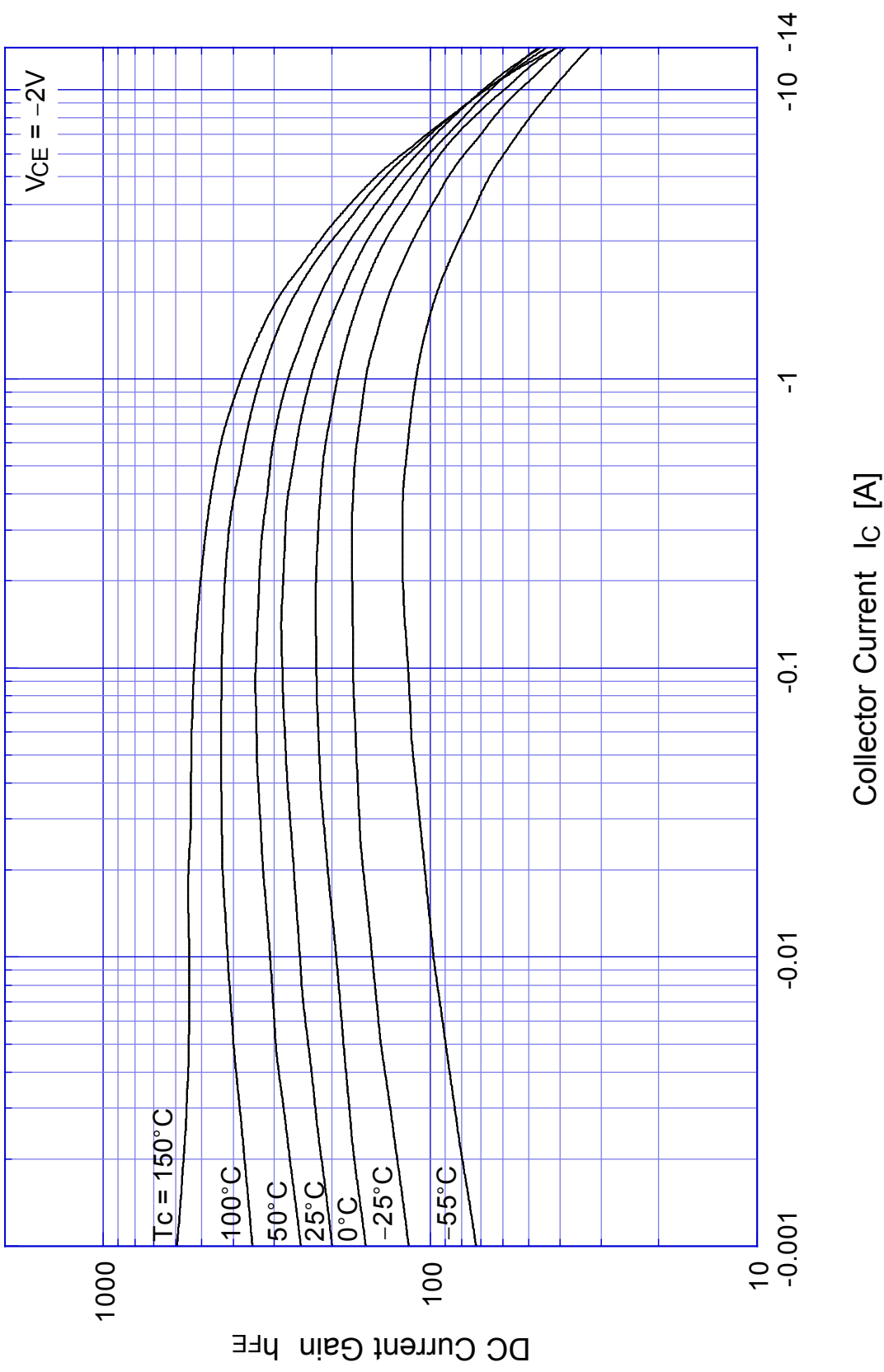

2SA1598 Saturation Voltage

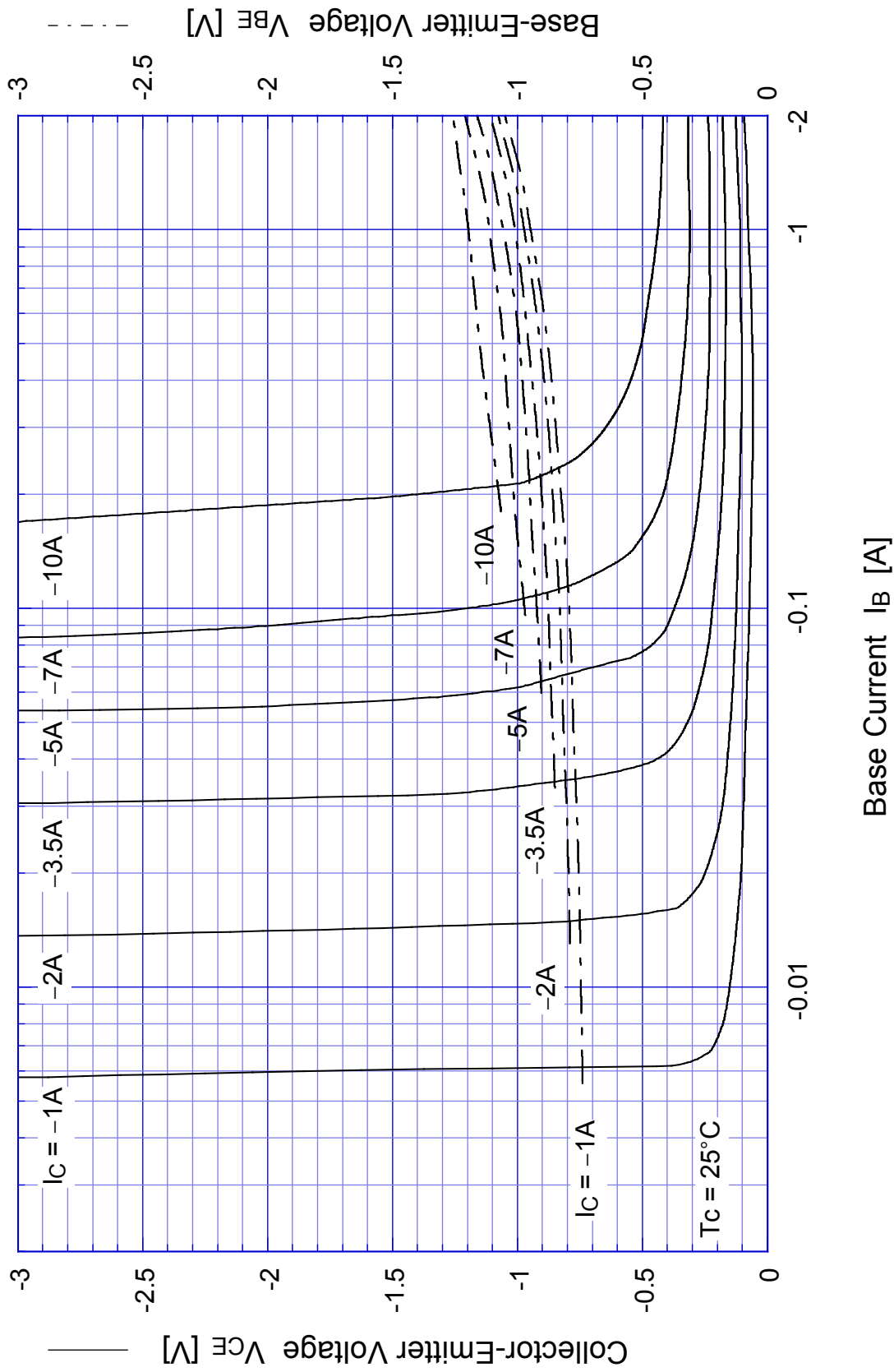

2SA1598

Switching Time - I_C

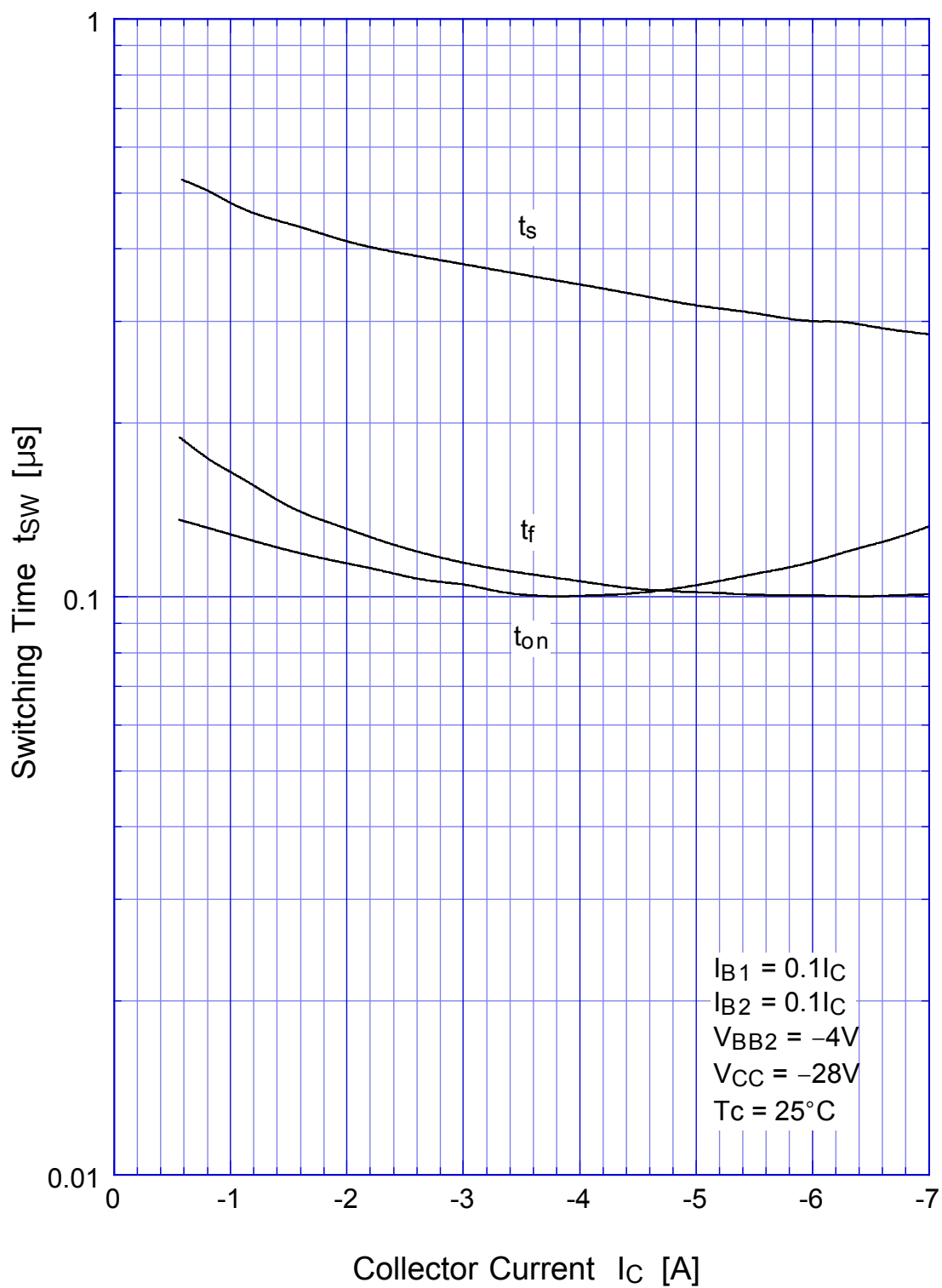

2SA1598

Switching Time - Tc

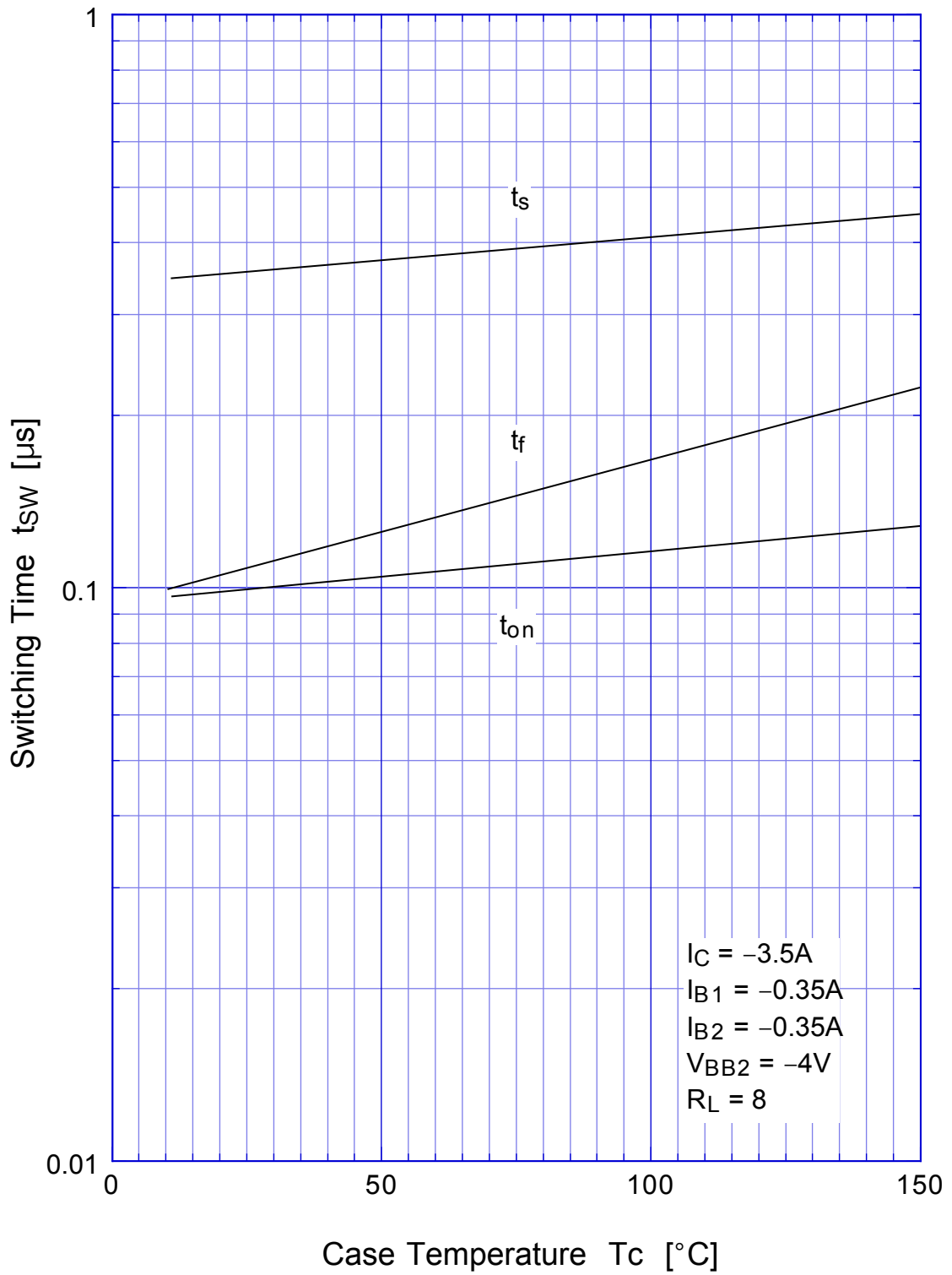

2SA1598 Transient Thermal Impedance

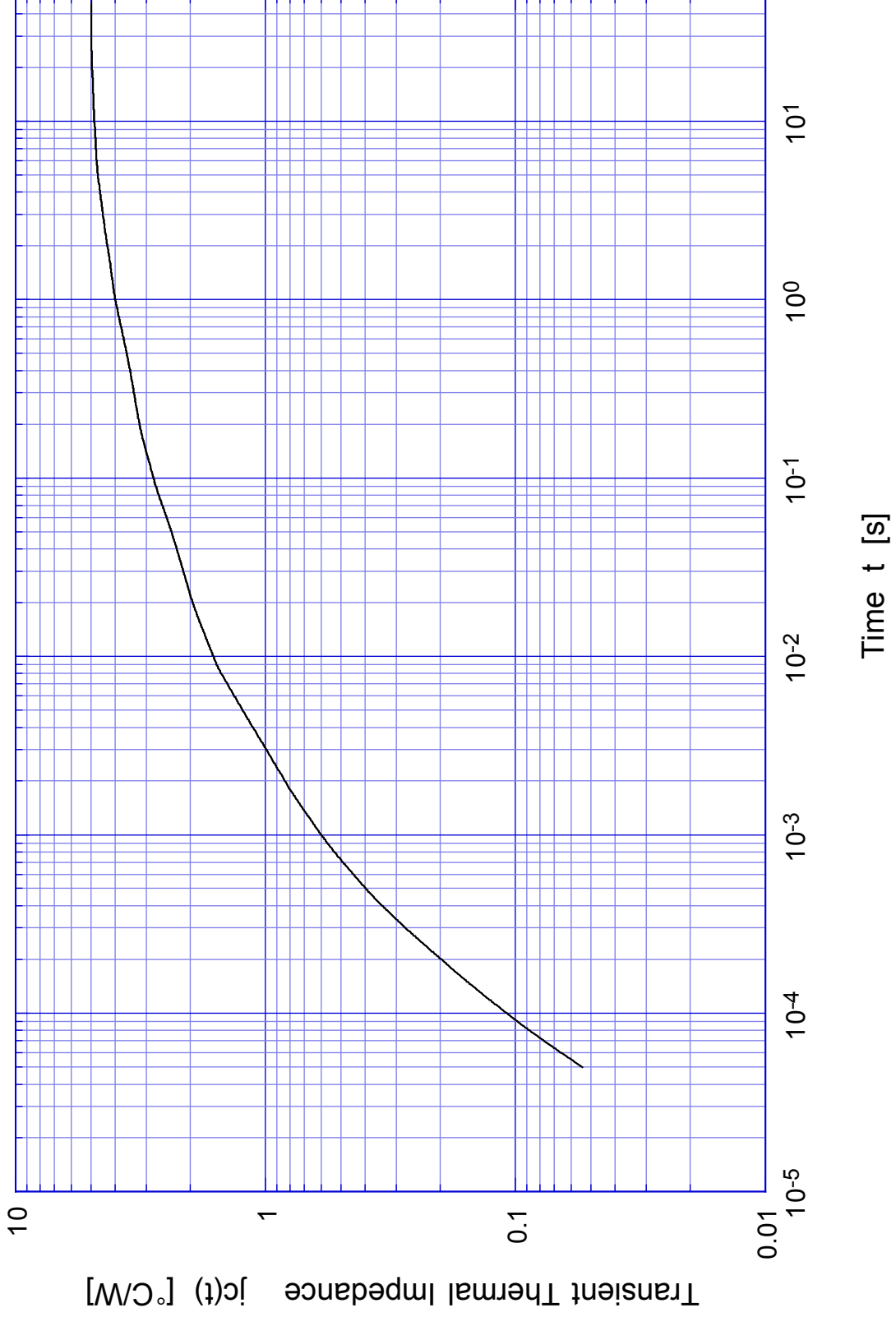

2SA1598

Forward Bias SOA

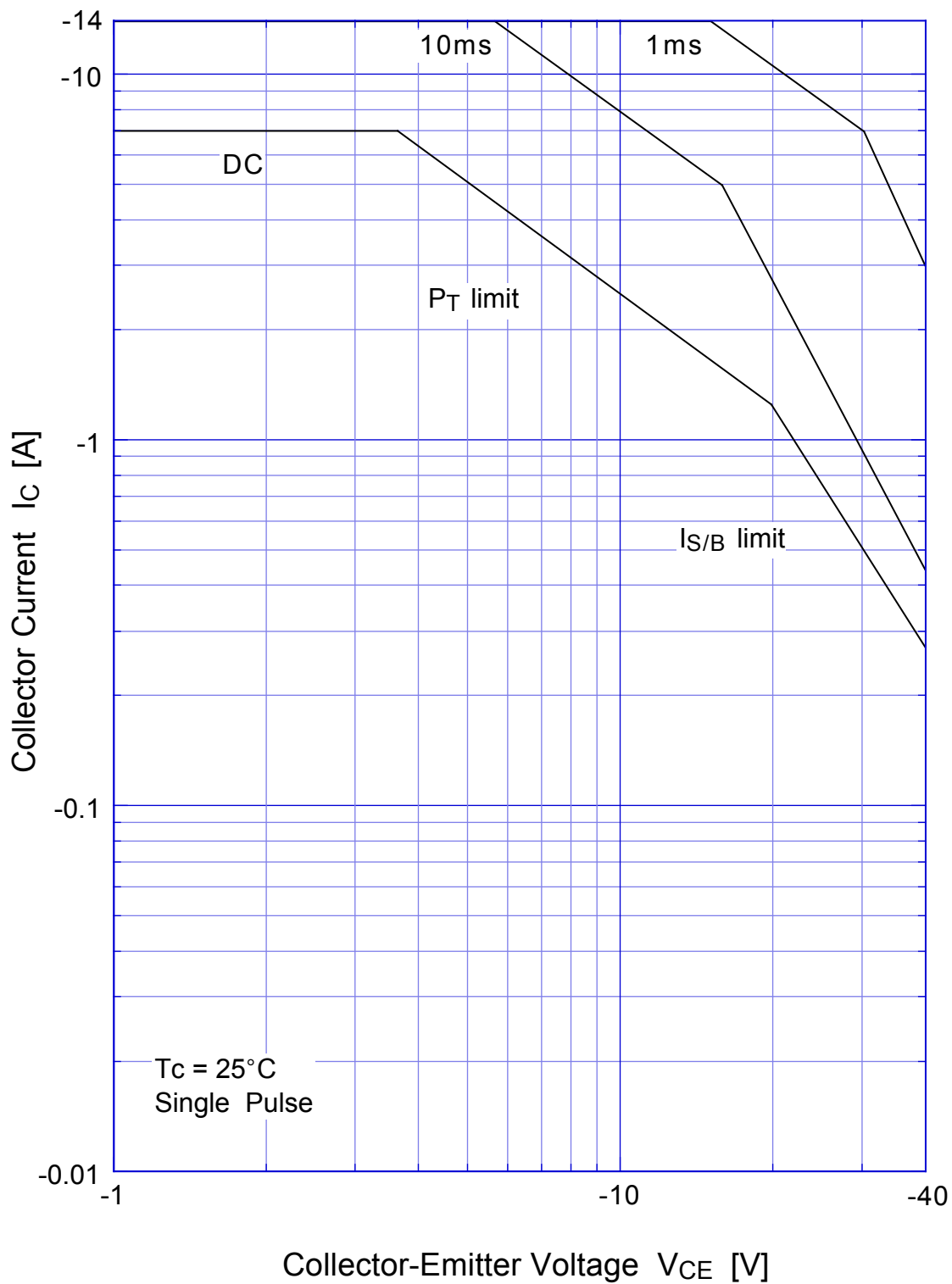

2SA1598 Collector Current Derating



2SA1598

Reverse Bias SOA

