

MPSA44

Preferred Device

High Voltage Transistor

NPN Silicon



ON Semiconductor®

<http://onsemi.com>

MAXIMUM RATINGS

Rating	Symbol	Value	Unit
Collector–Emitter Voltage	V_{CEO}	400	Vdc
Collector–Base Voltage	V_{CBO}	500	Vdc
Emitter–Base Voltage	V_{EBO}	6.0	Vdc
Collector Current – Continuous	I_C	300	mA _{dc}
Total Device Dissipation @ $T_A = 25^\circ\text{C}$ Derate above 25°C	P_D	625 5.0	mW mW/ $^\circ\text{C}$
Total Device Dissipation @ $T_C = 25^\circ\text{C}$ Derate above 25°C	P_D	1.5 12	Watts mW/ $^\circ\text{C}$
Operating and Storage Junction Temperature Range	T_J, T_{stg}	-55 to +150	$^\circ\text{C}$

THERMAL CHARACTERISTICS

Characteristic	Symbol	Max	Unit
Thermal Resistance, Junction–to–Ambient	$R_{\theta JA}$	200	$^\circ\text{C}/\text{W}$
Thermal Resistance, Junction–to–Case	$R_{\theta JC}$	83.3	$^\circ\text{C}/\text{W}$

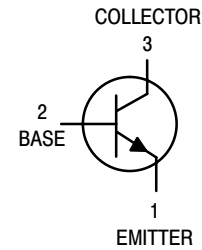

MARKING DIAGRAM



TO-92 (TO-226AA)
CASE 29-11
Style 1

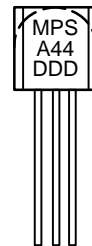

MPSA44= Specific Device Cod
DDD = Date Code

ORDERING INFORMATION

Device	Package	Shipping
MPSA44	TO-92	5000 Units / Bag
MPSA44RLRA	TO-92	2000 / Tape & Reel
MPSA44RL1	TO-92	2000 / Tape & Reel

Preferred devices are recommended choices for future use and best overall value.

MPSA44

ELECTRICAL CHARACTERISTICS (T_A = 25°C unless otherwise noted)

Characteristic	Symbol	Min	Max	Unit
OFF CHARACTERISTICS				
Collector–Emitter Breakdown Voltage (Note 1) (I _C = 1.0 mA _{dc} , I _B = 0)	V _{(BR)CEO}	400	–	V _{dc}
Collector–Emitter Breakdown Voltage (I _C = 100 μA _{dc} , V _{BE} = 0)	V _{(BR)CES}	500	–	V _{dc}
Collector–Base Breakdown Voltage (I _C = 100 μA _{dc} , I _E = 0)	V _{(BR)CBO}	500	–	V _{dc}
Emitter–Base Breakdown Voltage (I _E = 10 μA _{dc} , I _C = 0)	V _{(BR)EBO}	6.0	–	V _{dc}
Collector Cutoff Current (V _{CB} = 400 V _{dc} , I _E = 0)	I _{CBO}	–	0.1	μA _{dc}
Collector Cutoff Current (V _{CE} = 400 V _{dc} , V _{BE} = 0)	I _{CES}	–	500	nA _{dc}
Emitter Cutoff Current (V _{EB} = 4.0 V _{dc} , I _C = 0)	I _{EBO}	–	0.1	μA _{dc}
ON CHARACTERISTICS (Note 1)				
DC Current Gain (Note 1) (I _C = 1.0 mA _{dc} , V _{CE} = 10 V _{dc}) (I _C = 10 mA _{dc} , V _{CE} = 10 V _{dc}) (I _C = 50 mA _{dc} , V _{CE} = 10 V _{dc}) (I _C = 100 mA _{dc} , V _{CE} = 10 V _{dc})	h _{FE}	40 50 45 40	– 200 – –	–
Collector–Emitter Saturation Voltage (Note 1) (I _C = 1.0 mA _{dc} , I _B = 0.1 mA _{dc}) (I _C = 10 mA _{dc} , I _B = 1.0 mA _{dc}) (I _C = 50 mA _{dc} , I _B = 5.0 mA _{dc})	V _{CE(sat)}	– – –	0.4 0.5 0.75	V _{dc}
Base–Emitter Saturation Voltage (I _C = 10 mA _{dc} , I _B = 1.0 mA _{dc})	V _{BE(sat)}	–	0.75	V _{dc}
SMALL–SIGNAL CHARACTERISTICS				
Output Capacitance (V _{CB} = 20 V _{dc} , I _E = 0, f = 1.0 MHz)	C _{obo}	–	7.0	pF
Input Capacitance (V _{EB} = 0.5 V _{dc} , I _C = 0, f = 1.0 MHz)	C _{ibo}	–	130	pF
Small–Signal Current Gain (I _C = 10 mA _{dc} , V _{CE} = 10 V _{dc} , f = 20 MHz)	h _{fe}	1.0	–	–

1. Pulse Test: Pulse Width ≤ 300 μs, Duty Cycle ≤ 2.0%.

MPSA44

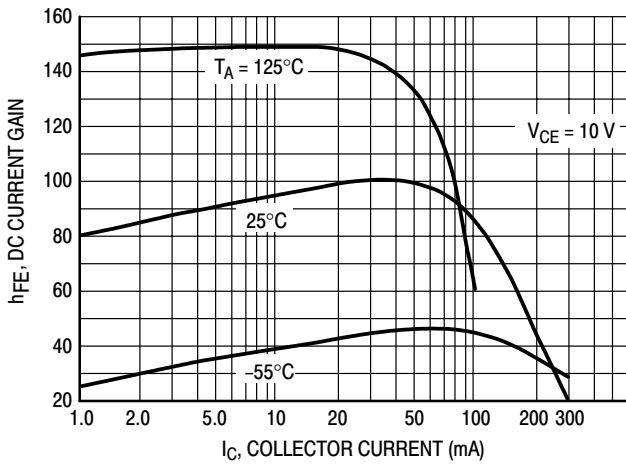

Figure 1. DC Current Gain

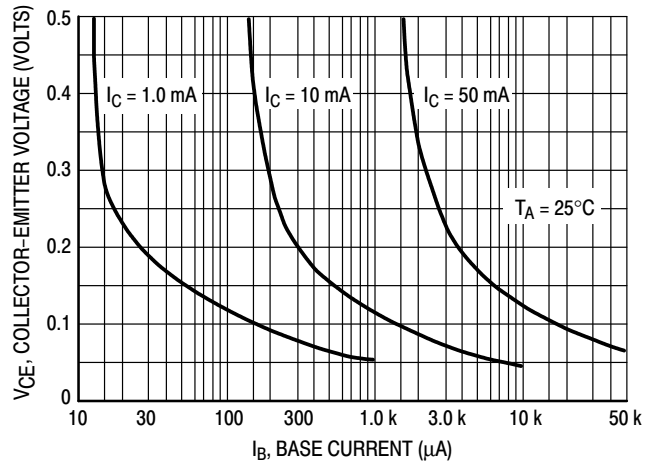

Figure 2. Collector Saturation Region

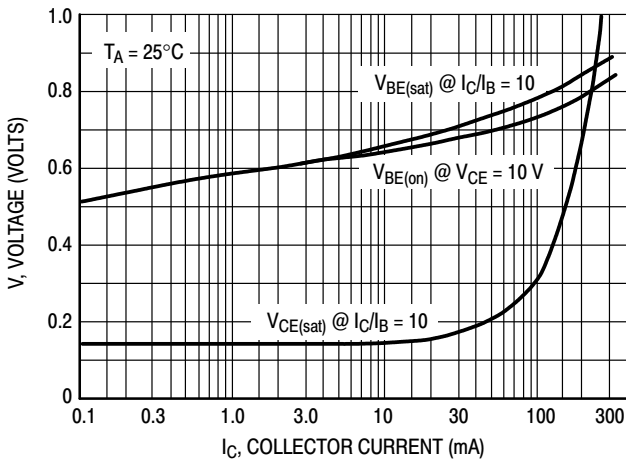

Figure 3. "On" Voltages

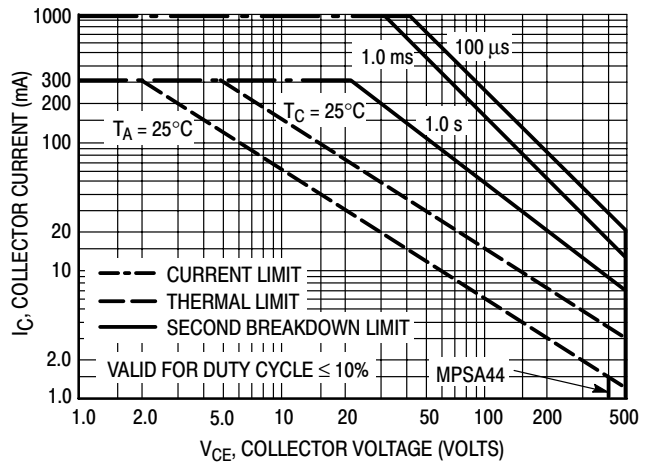

Figure 4. Active Region - Safe Operating Area

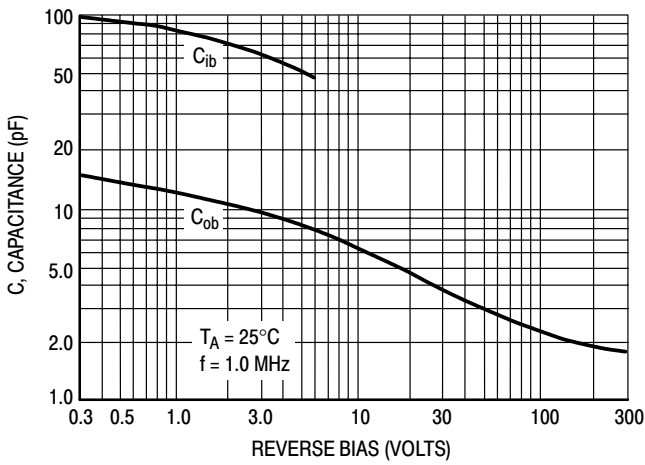

Figure 5. Capacitance

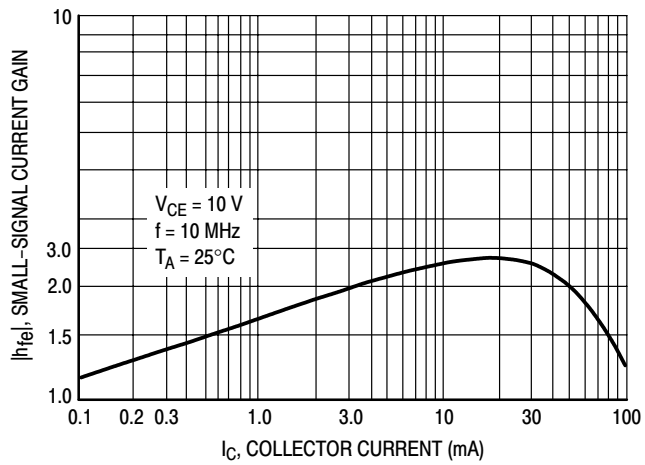

Figure 6. High Frequency Current Gain

MPSA44

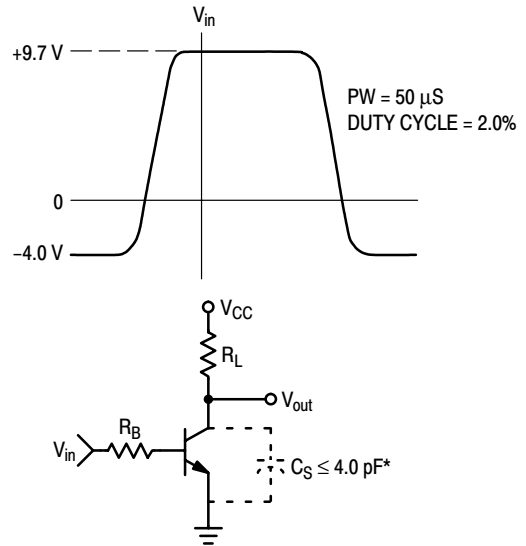
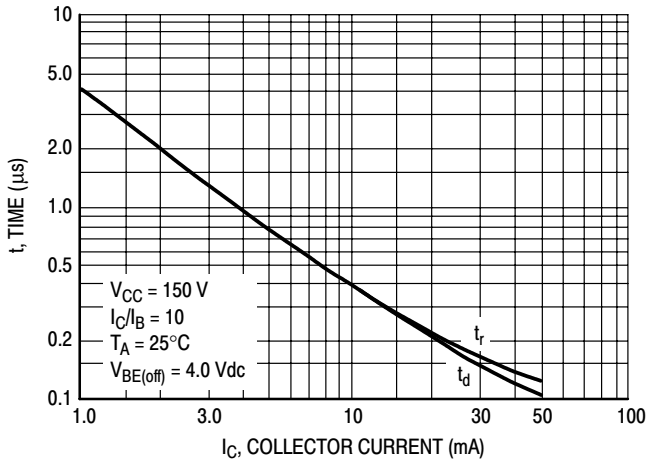

Figure 7. Turn-On Switching Times and Test Circuit

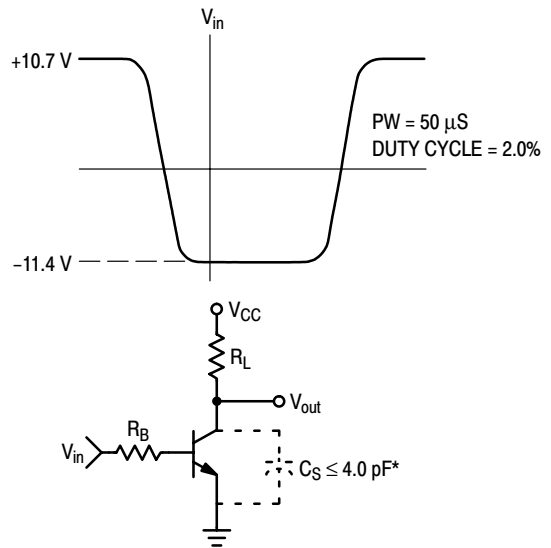
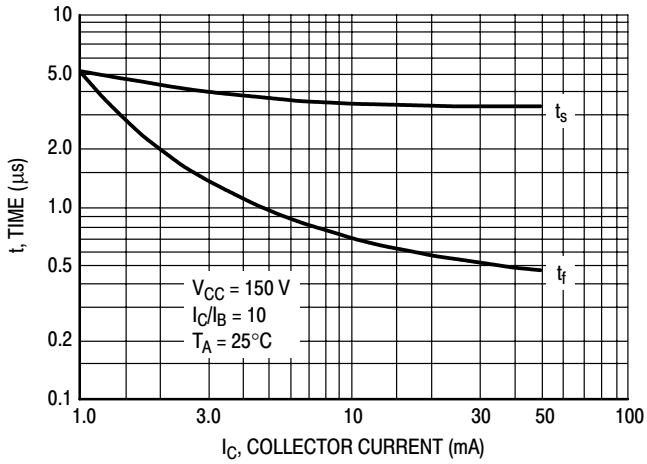

Figure 8. Turn-Off Switching Times and Test Circuit

*Total Shunt Capacitance of Test Jig and Connectors.

MPSA44

PACKAGE DIMENSIONS

TO-92 (TO-226)
CASE 29-11
ISSUE AL

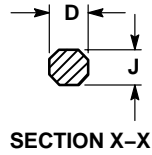
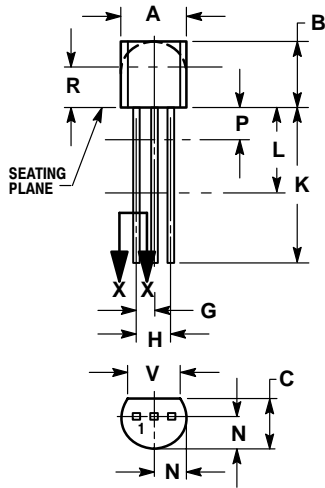

NOTES:

1. DIMENSIONING AND TOLERANCING PER ANSI Y14.5M, 1982.
2. CONTROLLING DIMENSION: INCH.
3. CONTOUR OF PACKAGE BEYOND DIMENSION R IS UNCONTROLLED.
4. LEAD DIMENSION IS UNCONTROLLED IN P AND BEYOND DIMENSION K MINIMUM.

DIM	INCHES		MILLIMETERS	
	MIN	MAX	MIN	MAX
A	0.175	0.205	4.45	5.20
B	0.170	0.210	4.32	5.33
C	0.125	0.165	3.18	4.19
D	0.016	0.021	0.407	0.533
G	0.045	0.055	1.15	1.39
H	0.095	0.105	2.42	2.66
J	0.015	0.020	0.39	0.50
K	0.500	---	12.70	---
L	0.250	---	6.35	---
N	0.080	0.105	2.04	2.66
P	---	0.100	---	2.54
R	0.115	---	2.93	---
V	0.135	---	3.43	---

STYLE 1:

1. EMITTER
2. BASE
3. COLLECTOR

MPSA44

ON Semiconductor and  are registered trademarks of Semiconductor Components Industries, LLC (SCILLC). SCILLC reserves the right to make changes without further notice to any products herein. SCILLC makes no warranty, representation or guarantee regarding the suitability of its products for any particular purpose, nor does SCILLC assume any liability arising out of the application or use of any product or circuit, and specifically disclaims any and all liability, including without limitation special, consequential or incidental damages. "Typical" parameters which may be provided in SCILLC data sheets and/or specifications can and do vary in different applications and actual performance may vary over time. All operating parameters, including "Typicals" must be validated for each customer application by customer's technical experts. SCILLC does not convey any license under its patent rights nor the rights of others. SCILLC products are not designed, intended, or authorized for use as components in systems intended for surgical implant into the body, or other applications intended to support or sustain life, or for any other application in which the failure of the SCILLC product could create a situation where personal injury or death may occur. Should Buyer purchase or use SCILLC products for any such unintended or unauthorized application, Buyer shall indemnify and hold SCILLC and its officers, employees, subsidiaries, affiliates, and distributors harmless against all claims, costs, damages, and expenses, and reasonable attorney fees arising out of, directly or indirectly, any claim of personal injury or death associated with such unintended or unauthorized use, even if such claim alleges that SCILLC was negligent regarding the design or manufacture of the part. SCILLC is an Equal Opportunity/Affirmative Action Employer. This literature is subject to all applicable copyright laws and is not for resale in any manner.

PUBLICATION ORDERING INFORMATION

LITERATURE FULFILLMENT:

Literature Distribution Center for ON Semiconductor
P.O. Box 5163, Denver, Colorado 80217 USA

Phone: 303-675-2175 or 800-344-3860 Toll Free USA/Canada

Fax: 303-675-2176 or 800-344-3867 Toll Free USA/Canada

Email: orderlit@onsemi.com

N. American Technical Support: 800-282-9855 Toll Free
USA/Canada

Japan: ON Semiconductor, Japan Customer Focus Center
2-9-1 Kamimeguro, Meguro-ku, Tokyo, Japan 153-0051
Phone: 81-3-5773-3850

ON Semiconductor Website: <http://onsemi.com>

Order Literature: <http://www.onsemi.com/litorder>

For additional information, please contact your
local Sales Representative.

This datasheet has been download from:

www.datasheetcatalog.com

Datasheets for electronics components.