

# 组合电缆

## 组合电缆

- 可按要求提供订制品 (改变长度或接头)。
- 有关价格和供货时间, 请联系我们了解详情。  
注有★及黑色以外的型号, 为非常备库存产品。

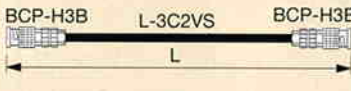
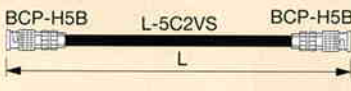
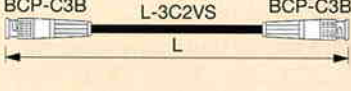
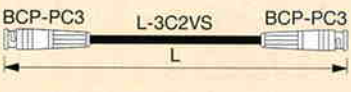
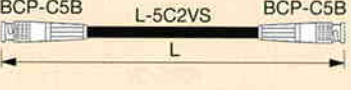

### BNC 带 75Ω BNC 连接头的电缆, 焊接型或压接型。

类型	型号	长度 (m)	
BNC (阳) - BNC (阳) 焊接型 	DH3C005-S	0.5	
	DH3C01-S	1	
	DH3C02-S	2	
	DH3C03-S	3	
	DH3C05-S	5	
	DH3C10-S	10	
	黑 棕 红 橙 黄 绿 蓝 灰 白		
	BNC (阳) - BNC (阳) 焊接型 	DH5C03-S	3
		DH5C05-S	5
		DH5C10-S	10
DH5C15-S		15	
DH5C20-S		20	
黑 棕 红 橙 黄 绿 蓝 灰 白			
BNC (阳) - BNC (阳) 焊接型 	D3C005-S	0.5	
	D3C01-S	1	
	D3C015-S	1.5	
	D3C02-S	2	
	D3C03-S	3	
	D3C05-S	5	
	D3C10-S	10	
	黑 棕 红 橙 黄 绿 蓝 灰 白		
	BNC (阳) - BNC (阳) 焊接型 	DP3C005-S	0.5
		DP3C01-S	1
DP3C015-S		1.5	
DP3C02-S		2	
DP3C03-S		3	
DP3C05-S		5	
DP3C10-S		10	
黑 棕 红 橙 黄 绿 蓝 灰 白			
BNC (阳) - BNC (阳) 焊接型 		D5C005-S	0.5
		D5C01-S	1
	D5C015-S	1.5	
	D5C03-S	3	
	D5C05-S	5	
	D5C10-S	10	
	D5C15-S	15	
	D5C20-S	20	
	黑 棕 红 橙 黄 绿 蓝 灰 白		

### RCA (视频用)

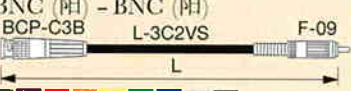
类型	型号	长度 (m)
BNC (阳) - BNC (阳) 	D3C01-SR	1
	D3C03-SR	3
	D3C05-SR	5
黑 棕 红 橙 黄 绿 蓝 灰 白		

### 新

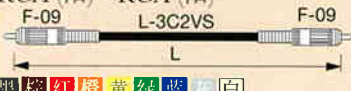
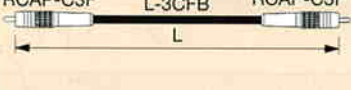
类型	型号	长度 (m)
RCA (阳) - RCA (阳) 	DRC01-S	1
	DRC03-S	3
	DRC05-S	5
黑 棕 红 橙 黄 绿 蓝 灰 白		
RCA (阳) - RCA (阳) 	DRC10-F3	10
	DRC15-F3	15
	DRC20-F3	20
	DRC30-F3	30
	DRC40-F3	40
黑 红 黄 绿 蓝 白		

### 视频跳线

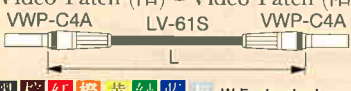
类型	型号	长度 (m)
Video Patch (阳) - Video Patch (阳) 	VPC003-WC	0.3
	VPC005-WC	0.5
	VPC01-WC	1
	黑 棕 红 橙 黄 绿 蓝 灰 W.E. standard	

### 新

### 分量 色差输入/输出信号电缆 3CFB 信道单元保证卓越的传输特性。

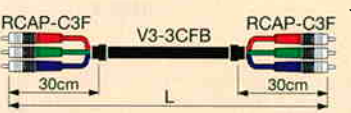
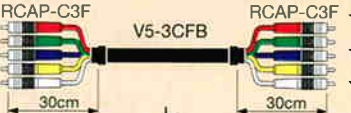
类型	型号	长度 (m)	
RCA (阳) - RCA (阳) 	★ 3VS02-3CFB-RCAP	2	
	★ 3VS03-3CFB-RCAP	3	
	★ 3VS05-3CFB-RCAP	5	
	★ 3VS10-3CFB-RCAP	10	
	★ 3VS15-3CFB-RCAP	15	
	★ 3VS20-3CFB-RCAP	20	
	黑		
	RCA (阳) - RCA (阳) 	★ 5VS02-3CFB-RCAP	2
		★ 5VS03-3CFB-RCAP	3
		★ 5VS05-3CFB-RCAP	5
★ 5VS10-3CFB-RCAP		10	
★ 5VS15-3CFB-RCAP		15	
★ 5VS20-3CFB-RCAP		20	
黑			



3VS02-3CFB-RCAP

### BNC (多讯道)

多讯道 75Ω 同轴电缆减少了分量信号经过不同长度电缆传输后产生的相应位差的校准。

新

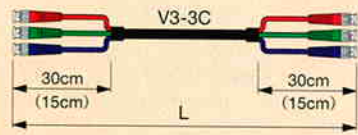
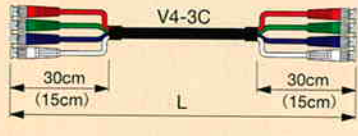
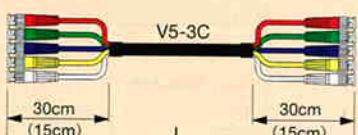
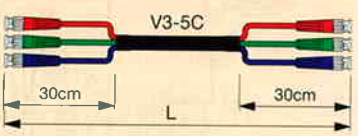
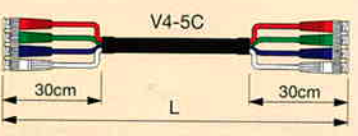
类型	使用的连接头	BCP-C3B	BCP-PC3	BCP-H3B	长度 (m)		
		型号	型号	型号			
BNC (阳) - BNC (阳) (3C2VS单元)		3VS01-3C	★3VS01-3CP	★3VS01-3CH	1		
		3VS02-3C	★3VS02-3CP	★3VS02-3CH	2		
		3VS03-3C	★3VS03-3CP	★3VS03-3CH	3		
		3VS05-3C	★3VS05-3CP	★3VS05-3CH	5		
		3VS08-3C	★3VS08-3CP	★3VS08-3CH	8		
		3VS10-3C	★3VS10-3CP	★3VS10-3CH	10		
		4VS01-3C	★4VS01-3CP	★4VS01-3CH	1		
		4VS02-3C	★4VS02-3CP	★4VS02-3CH	2		
		4VS03-3C	★4VS03-3CP	★4VS03-3CH	3		
		4VS05-3C	★4VS05-3CP	★4VS05-3CH	5		
BNC (阳) - BNC (阳) (4C2VS单元)		4VS08-3C	★4VS08-3CP	★4VS08-3CH	8		
		4VS10-3C	★4VS10-3CP	★4VS10-3CH	10		
		5VS01-3C	★5VS01-3CP	★5VS01-3CH	1		
		5VS02-3C	★5VS02-3CP	★5VS02-3CH	2		
		5VS03-3C	★5VS03-3CP	★5VS03-3CH	3		
		5VS05-3C	★5VS05-3CP	★5VS05-3CH	5		
		5VS08-3C	★5VS08-3CP	★5VS08-3CH	8		
		5VS10-3C	★5VS10-3CP	★5VS10-3CH	10		
		5VS15-3C	—	—	15		
		5VS20-3C	—	—	20		
BNC (阳) - BNC (阳) (5C2VS单元)		5VS30-3C	—	—	30		
		类型	使用的连接头	BCP-C5B	BCP-PC5	BCP-H5B	长度 (m)
		型号	型号	型号			
		BNC (阳) - BNC (阳) (5C2VS单元)		3VS03-5C	★3VS03-5CP	★3VS03-5CH	3
				3VS05-5C	★3VS05-5CP	★3VS05-5CH	5
				3VS08-5C	★3VS08-5CP	★3VS08-5CH	8
				3VS10-5C	★3VS10-5CP	★3VS10-5CH	10
				3VS15-5C	★3VS15-5CP	★3VS15-5CH	15
				3VS20-5C	★3VS20-5CP	★3VS20-5CH	20
				4VS03-5C	★4VS03-5CP	★4VS03-5CH	3
4VS05-5C	★4VS05-5CP			★4VS05-5CH	5		
4VS08-5C	★4VS08-5CP			★4VS08-5CH	8		
4VS10-5C	★4VS10-5CP			★4VS10-5CH	10		
BNC (阳) - BNC (阳) (5C2VS单元)		4VS15-5C	★4VS15-5CP	★4VS15-5CH	15		
		4VS20-5C	★4VS20-5CP	★4VS20-5CH	20		
		5VS03-5C	★5VS03-5CP	★5VS03-5CH	3		
		5VS05-5C	★5VS05-5CP	★5VS05-5CH	5		
		5VS08-5C	★5VS08-5CP	★5VS08-5CH	8		
		5VS10-5C	★5VS10-5CP	★5VS10-5CH	10		
		5VS15-5C	★5VS15-5CP	★5VS15-5CH	15		
		5VS20-5C	★5VS20-5CP	★5VS20-5CH	20		

括号内数字表示总长度为 1 米的组合电缆的该部



5 VS03-5C



连接头: BCP-C3B



连接头: BCP-PC3





连接头BCP-H3B

• 有关连接头详情, 请参见P11和 P12。

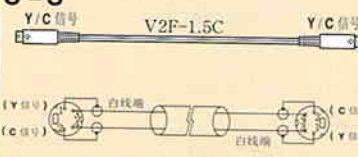
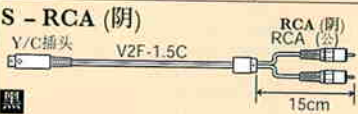
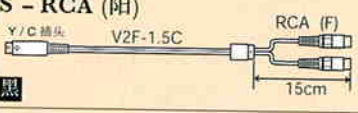
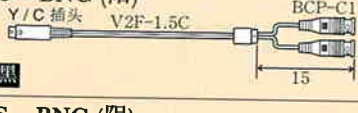

### S接头电缆

用于商用录像机、电视机等S接线端子(Y/C signal)输出的电缆。30公分长度电缆用做延长线。

类型	型号	长度 (m)
<b>S - S</b> 	2VC02-F1.5C	2
	2VC03-F1.5C	3
	2VC05-F1.5C	5
	2VC10-F1.5C	10
	黑	
<b>S - RCA (阴)</b> 	2VS003-FR1.5C	0.3
	黑	
<b>S - RCA (阳)</b> 	2VS003-FRJ1.5C	0.3
	黑	
<b>S - BNC (阴)</b> 	2VS003-F1.5C	0.3
	黑	
<b>S - BNC (阳)</b> 	2VS003-FJ1.5C	0.3
	黑	

•V2F-1.5C 和 BCJ-RUC1-RE 不单独销售。

### 电视摄影机用

用于连接摄像机与CCU。

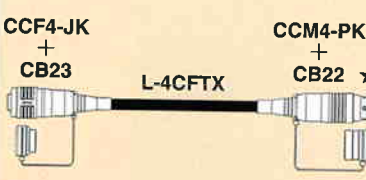
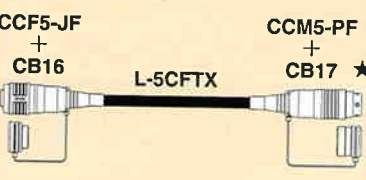
类型	型号	长度 (m)
<b>Triaxial(阴) - Triaxial(阳)</b> 	TXC ** - K - SB	
<b>Triaxial(阴) - Triaxial(阳)</b> 	TXC ** - F - SB	

\*\*：电缆长度

### 音频用

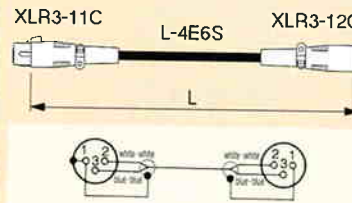
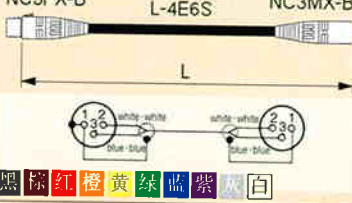
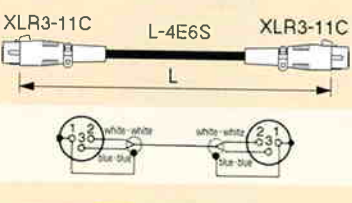
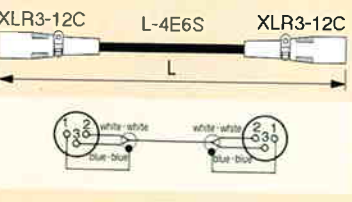
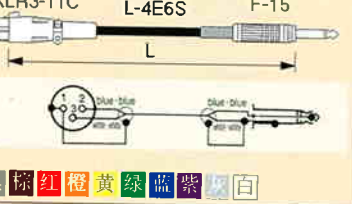
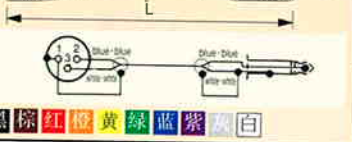
类型	型号	长度 (m)	
<b>XLR3 (阴) - XLR3 (阳)</b> 	EC003	0.3	
	EC005	0.5	
	EC01	1	
	EC015	1.5	
	EC02	2	
	EC03	3	
	EC05	5	
	EC07	7	
	EC10	10	
	EC15	15	
	EC20	20	
	<b>NC3 (阴) - NC3 (阳)</b> 	EC015-B	1.5
		EC03-B	3
		EC05-B	5
		EC07-B	7
EC10-B		10	
<b>XLR3 (阴) - XLR3 (阴)</b> 	EC003-X11	0.3	
	EC005-X11	0.5	
	EC01-X11	1	
	EC015-X11	1.5	
	EC02-X11	2	
<b>XLR3 (阳) - XLR3 (阳)</b> 	EC003-X22	0.3	
	EC005-X22	0.5	
	EC01-X22	1	
	EC015-X22	1.5	
	EC02-X22	2	
<b>XLR3 (阴) - Phone (mono) (阳)</b> 	PC03	3	
	PC05	5	
	PC07	7	
	PC10	10	
	<b>NC3 (阴) - Phone (mono) (阳)</b> 	PC03-B	3
PC05-B		5	
PC07-B		7	

光纤系统

连接接头

工具

电缆

跳线盘

多信道系统

组合电缆